



YOUR SINGLE SOURCE FOR QUALITY



2016|17

**FIREPLACE,**  
PELLET & WOOD  
STOVE FAN KITS,  
BLOWERS, MOTORS  
& ACCESSORIES

[www.alltemp.ca](http://www.alltemp.ca)

**Acorn, Selkirk**

Acorn Wood Stove 71730867, 2868509042  
Selkirk 605850M0

Part #	HP	Volts	Amps	Type	RPM	Rot.	Body	Frame	Bearing	Shaft
<b>HM-R250</b>	1/70	115	0.65	SP/TE	2/1500	CCW	3.5"	3.3"	Sleeve	1.6"x5/16"

HM-R250 Includes 3 prong plug, built in end switch, threaded shaft end with hub.



**Buck Stove**

Wood Stove R22CCW270ZD, 7163-5967, 7163-6045 (HM-R1138)  
Wood Stove R22CW206MD (HM-R1139)

Part #	HP	Volts	Amps	Type	RPM	Rot.	Body	Frame	Bearing	Shaft
<b>HM-R1138</b>	1/50 1/80 1/140	115	.88, .60, .45	SP/ Open	3/1550	CCW	4.0"	3.9"	Sleeve	2.5"x5/16"
<b>HM-R1139</b>	1/50 1/80 1/125	115	.88, .61, .46	SP/ Open	3/1550	CCW	2.8"	3.3"	Sleeve	2.5"x5/16"x1.125"

HM-R1138 Band mounting, HM-R1139 Stud Mounting

**HM-R1138**  
*illustrated*



**HM-R1139**  
*illustrated*



**R7-RB440**  
*illustrated*



**R7-RB155**  
*illustrated*

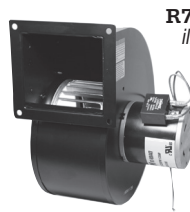

**R7-RB447**  
*illustrated*

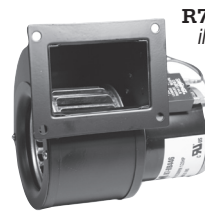

**R7-RB446**  
*illustrated*

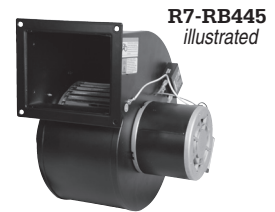

**R7-RB445**  
*illustrated*

**Dayton, Grainger - Additional replacements on page 13 & 14**

Part #	HP	Volts	Amps	Type	RPM	Rot.	CFM	Frame	Bearing	Comment
<b>R7-RB440</b>	1/125	115	0.25	PSC/ Open	1/3080	CW	50	3.3"	Ball	1TDN7, 4C440
<b>R7-RB155</b>	1/40	115	0.75	PSC/TE	1/2480	CW	148	3.3"	Ball	Grainger 1TDR6, 4C006, Fasco 7021-4933
<b>R7-RB447</b>	1/25	115	0.77	PSC/ Open	1/1640	CW	273	3.3"	Ball	Grainger 1TDR3, 4C447
<b>R7-RB446</b>	1/20	115	0.75	PSC/ Open	1/3120	CW	146	3.3"	Ball	Grainger 1TDP7, 4C446, Fasco 7021-3469, Wood Doctor Furnace
<b>R7-RB445</b>	1/6	115	2.20	PSC/ Open	1/1430	CW	549	3.3"	Ball	1TDT2, 4C445, 4YJ32

R7-RB440 Includes intake screen guard, round discharge - round flange.

**Elmira**

Elmira Wood Stove 1500, 1600

Part #	HP	Volts	Amps	Type	RPM	Rot.	Body	Frame	Bearing	Shaft
<b>HM-R489</b>	1/60	115	0.72	SP/ Open	3/1300	CW	2.5"	3.3"	Sleeve	3.6"x5/16"x3.5"



**Elmira**

Wood Stove Blower

Part #	HP	Volts	Amps	Type	RPM	Rot.	CFM	Body	Frame	Bearing
<b>R7-RB34</b>	1/25	120	0.60	ECM/Open	1/2800	CW	73	6.6"	3.3"	Ball

HB-RB34 Includes intake screen guard, built-in variable speed control, 3-prong plug, round discharge - large square flange.



**Elmira**

Elmira (Wood Stove)

Part #	Watts	Amps	Volts	RPM	Rot.	CFM	Blower	Blower Wheel	Bearing
<b>HB-RB200T</b>	35	0.60	115	1600	CCW	200	15"x4.25"x4.25"	65x240mm (2.6x9.4")	Sleeve

HB-RB200T Features 8.3' cord & 3 prong plug

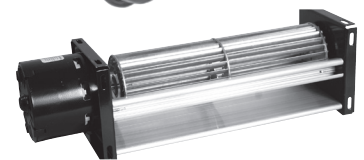

**Enviro**

Enviro EFW261, EF1000, 1600, 2160, 1200, 1700

Part #	Watts	Amps	Volts	RPM	Rot.	CFM	Blower	Blower Wheel	Bearing
<b>HB-RB261</b>	50	0.80	115	1450	CW	130	16"x4.8"x4.25"	65x240mm (2.6x9.4")	Sleeve



**Enviro**

Enviro 50-2981, Q2 Gas Fireplace

Part #	Watts	Amps	Volts	RPM	Rot.	CFM	Blower	Blower Wheel	Bearing
<b>HB-RB981</b>	50	0.82	115	2075	CCW	122	12.8"x4.6"x4.3"	76x101mm (3x4")	Ball

Includes blower, mounting plate, thermal switch, and variable speed control



# OEM Replacement

## Blowers, Motors & Fan Kits



### Heat & Glo Blower Kit

Heat & Glo GFK-160A  
Fasco 7002-1241, A133



Blower Kit	Blower Only	Watts	Amps	Volts	RPM	Rot.	CFM	Blower	Blower Wheel	Bearing
<b>HB-RB168</b>	<b>HB-RB168B</b>	53	0.92	115	1/2400	CCW	125	12.8"x4.6"x4.3"	76x101mm (3x4")	Ball

HB-RB168 Includes blower with magnetic mounting, thermal switch assembly, variable speed control, wiring harness - cord with two prong plug.

### Heatilator

Heatilator FK21 (Old Kit), GFK21 (New Kit)  
Novus 30, Security UZY3

Part #	Watts	Amps	Volts	RPM	Rot.	CFM	Blower	Blower Wheel	Bearing
<b>HB-RB21K</b>	35	0.57	115	1/1800	CCW	80	8.0"x4.3"x3.6"	65x120mm (2.6x4.7")	Sleeve

HB-RB21K Includes blower, thermal switch assembly, variable speed control - cord with three prong plug.



### Heatilator

Heatilator FK4 (Old Kit), GFK4 (New Kit)

Part #	Watts	Amps	Volts	RPM	Rot.	CFM	Blower	Blower Wheel	Bearing
<b>HB-RB74K</b>	50	0.86	115	1/1450	CW	130	12.9"x4.3"x3.6"	65x240mm (2.6x9.4")	Sleeve

HB-RB74K Includes blower, velcro mounting strips, thermal switch assembly, variable speed control - cord with three prong plug.

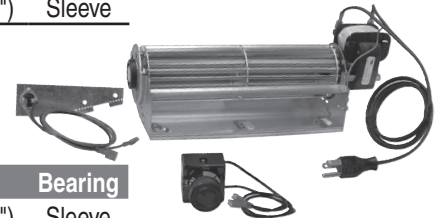

### Heritage

Wood Stove Blower

Part #	HP	Volts	Amps	Type	RPM	Rot.	CFM	Body	Frame	Bearing
<b>R7-RB34</b>	1/25	120	0.60	ECM/Open	1/2800	CW	73	6.6"	3.3"	Ball

HB-RB34 Includes intake screen guard, built-in variable speed control, 3-prong plug, round discharge - large square flange.



### Heritage

Heritage & Nordica Diamond Wall Furnace Blower  
Newmac Wood Furnace 2040001

Part #	HP	Volts	Amps	Type	RPM	Rot.	CFM	Body	Frame	Bearing
<b>R7-RB33</b>	1/25	120	0.60	ECM/Open	1/2800	CW	73	6.6"	3.3"	Ball

R7-RB33 Features a built-in variable speed control & 72" cord with 3 prong plug.



### Heritage

Heritage Wood Insert

Part #	HP	Volts	Amps	Type	RPM	Rot.	CFM	Body	Frame	Bearing
<b>HB-RB125</b>	1/70	115	1.10	SP/Open	1/3200	CCW	125+	6.6"	3.3"	Sleeve



### Heritage

Heritage 8011

Part #	Watts	Amps	Volts	RPM	Rot.	CFM	Blower	Blower Wheel	Bearing
<b>HB-RB82</b>	42	0.72	115	1/1600	CW	110	10.5"x4.3"x3.6"	65x180mm (2.6x7.1")	Ball



### Hunter

Hunter - 770 (Kit), HDS2000, HDS3000, HFI30, HDV31, MGDV31, SFDV20 (Models)

Part #	Watts	Amps	Volts	RPM	Rot.	CFM	Blower	Blower Wheel	Bearing
<b>HB-RB68</b>	50	0.86	115	1/1450	CW	130	12.9"x4.3"x3.6"	65x240mm (2.6x9.4")	Ball

HB-RB68 Includes instructions, blower, mounting base, thermal switch assembly & variable speed control - cord with three prong plug.

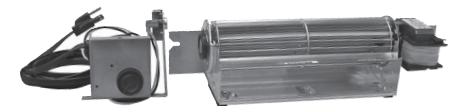

### Hunter

Hunter F125H, HWF30, HDV30

Part #	Watts	Volts	Amps	RPM	Rot.	CFM	Blower	Blower Wheel	Bearing
<b>HB-RB79</b>	62	115	0.72	1/1200	CCW	150	15.7"x4.3"x3.6"	65x300mm (2.6x11.8")	Ball

HB-RB79 blower only.

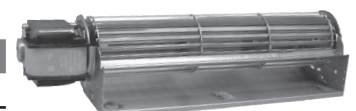

### Hunter

Hunter Wall Heater 917254

Part #	HP	Volts	Amps	Type	RPM	Rot.	CFM	Body	Frame	Bearing
<b>HB-RB91</b>	1/250	115	0.30	SP/ Open	1/1500	CCW	50	5.5"	3.3"	Sleeve

HB-RB91 Includes round discharge - no flange.

### Hunter

Hunter Wall Heater 2SR (Model)

Part #	HP	Volts	Amps	Type	RPM	Rot.	Body	Frame	Bearing	Shaft
<b>HM-R325</b>	1/125	115	0.40	SP/ Open	1/1500	CCW	1.94"	3.3"	Sleeve	2.3"x1/4"

HM-R325 Includes 5/16" shaft adapter.

### Hunter, Napoleon, Valor

Fasco 7063-7735 Exhaust Blower

Part #	HP	Volts	Amps	Type	RPM	Rot.	Body	Frame	Bearing
<b>HB-RB735</b>	1/125	115	0.36	SP/ Open	1/1500	CCW	5.7"	3.3"	Sleeve

HB-RB735 Includes 3 prong plug, mounting nuts & bolts.

### Kingsman/Marquis

Z33FK - ZDV3320 ZDV6000 - HB-RB37

F35FK - FDV350, FV, FDV5000, 4000 - HB-RB35

Z36FK - ZDV3600, ZDV4200N - HB-RB36

Part #	Watts	Amps	Volts	RPM	Rot.	CFM	Blower	Blower Wheel	Bearing
<b>HB-RB37</b>	42	0.75	115	1/1400	CCW	110	10.5"x4.3"x3.6"	65x180mm (2.6x7.1")	Ball
<b>HB-RB35</b>	50	0.86	115	1/1450	CW	130	12.9"x4.3"x3.6"	65x240mm (2.6x9.4")	Ball
<b>HB-RB36</b>	50	0.86	115	1/1450	CW	130	12.9"x4.3"x3.6"	65x240mm (2.6x9.4")	Ball

Kits include, blower, mounting base, thermal switch assembly & variable speed control - cord with three prong plug.

### Kozy Heat

600-1, EM3030L-211

Part #	Amps	Volts	RPM	Rot.	CFM	Blower	Blower Wheel	Bearing
<b>HB-RB6001</b>	1.22	115	1/1612	CCW	210	11"x3.75"x4.25"(2)	65x180mm (2)	Ball

Includes two blowers, mounting base, thermal switch, & 3 prong plug.

### Lennox

FBK-250, BL65X, D-400, D-500, D-600, D-800, B-500, B-600, B-800, MDT3328, MDR3328, Elite-2 Series, EDST-2,EDPF-2, EDCL-2, EDCR-2

Blower Kit	Blower Only	Watts	Amps	Volts	RPM	Rot.	CFM	Blower	Blower Wheel	Bearing
<b>HB-RB250</b>	<b>HB-RB100</b>	50	0.86	115	1/1200	CCW	130	12.9"x4.3"x3.6"	65x240mm (2.6x9.4")	Ball

HB-RB250 blower, speed control/thermal switch assembly, cord - 3 prong plug.

### Majestic, CFM

CFM-FK30, Instaflame 52425

New Energy Distributing - AD1 Single

Part #	Watts	Amps	Volts	RPM	Rot.	CFM	Blower	Blower Wheel	Bearing
<b>HB-RB130</b>	53	0.56	115	1/2800	CCW	70	8"x4.56"x4.32"	76x101mm (3x4")	Ball

HB-RB130 blower, magnetic mounting legs, cord - 2 prong plug.

### Majestic, Vermont Casting, CFM

CFM - FK24 (fan only), RHE32, Lennox 18L46, Majestic HE30,HE32, Travis (Gas)

Part #	Watts	Amps	Volts	RPM	Rot.	CFM	Blower	Blower Wheel	Bearing
<b>HB-RB64</b>	50	0.86	115	1/1450	CW	130	12.9"x4.3"x3.6"	65x240mm (2.6x9.4")	Ball

HB-RB64 blower only.

### Majestic, CFM

CFM - FA20(Model 1800), Majestic HE20 (Model)

Part #	Watts	Amps	Volts	RPM	Rot.	CFM	Blower	Blower Wheel	Bearing
<b>HB-RB82</b>	42	0.75	115	1/1600	CW	110	10.5x4.3x3.6"	65x180mm (2.6x7.1")	Ball

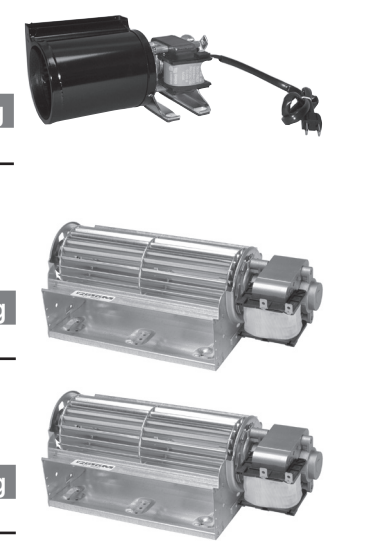
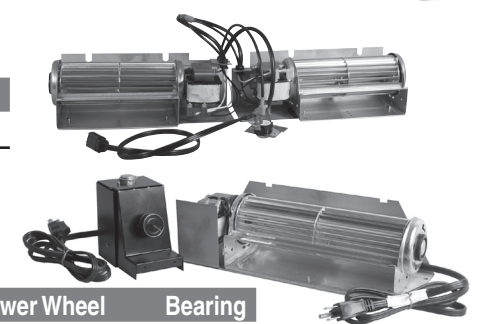
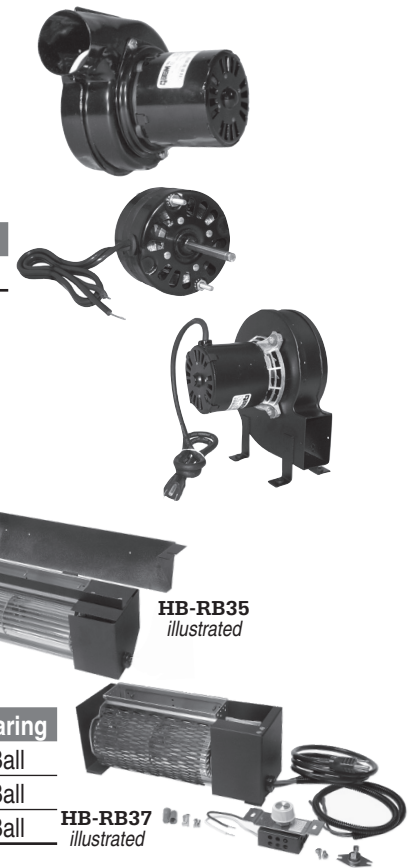

# OEM Replacement



## Blowers, Motors & Fan Kits

### Majestic, Vermont Casting, CFM

Majestic FK12

Part #	Watts	Amps	Volts	RPM	Rot.	CFM	Blower	Blower Wheel	Bearing
<b>HB-RB12</b>	50	0.86	115	1/1450	CW	130	12.9"x4.3"x3.6"	65x240mm (2.6x9.4")	Ball

Includes, cord, & 3 prong plug.



### Majestic, Vermont Casting, CFM

Majestic FK24 (Blower), 33DBVRRN, DBT33,36,39, DBR33,36,39 (Model)

Northern Flame FK24, A232, D232

Blower Kit	Blower & Base	Watts	Amps	Volts	RPM	Rot.	CFM	Blower	Blower Wheel	Bearing
<b>HB-RB65</b>	<b>HB-RB63</b>	50	0.86	115	1/1450	CW	130	12.9"x4.3"x3.6"	65x240mm (2.6x9.4")	Ball

HB-RB65 Includes blower, mounting base w/ foam strips, thermal switch assembly & variable speed control - cord with three prong plug.

HB-RB63 Includes blower with mounting base plate.

### Monessen

Monessen BLOT

Part #	Watts	Amps	Volts	RPM	Rot.	CFM	Blower	Blower Wheel	Bearing
<b>HB-RB94</b>	50	0.86	115	1450	CW	130	12.9"x4.3"x3.6"	65x240mm (2.6x9.4")	Ball

Includes blower with Velcro mounting strips, variable speed control, & thermal switch

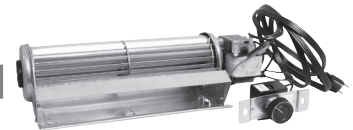

### Monessen

Monessen BLOT SC

Part #	Watts	Amps	Volts	RPM	Rot.	CFM	Blower	Blower Wheel	Bearing
<b>HB-RB95</b>	50	0.86	115	1450	CW	130	12.9"x4.3"x3.6"	65x240mm (2.6x9.4")	Ball

Includes blower with Velcro mounting strips



### Montigo, Selkirk

Electrohome 2811-581-001, EF100, T1-RF100 (Old Rotom 1spd), 2811-581-002, EF100-2

Part #	HP	Amps	Volts	Type	RPM	Rot.	CFM	Body	Frame	Bearing
<b>T1-RF100-2</b>	1/167	0.50	115	SP/Open	2/3000	CCW	100	2.75	Skel.	Sleeve

T1-RF100-2 blower includes mounting bracket & fan blade.



**HB-RB58**  
Complete  
Blower Kit

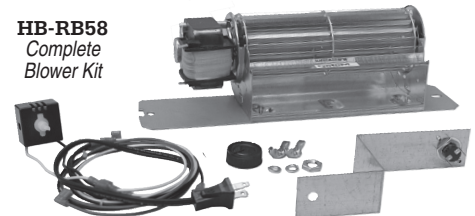

### Napoleon, Continental, Wolf Steel

Continental GZ550, BCDV36NTR (Gas)

Napoleon GZ550 (Blower), GD36NTR (Gas)

Fits most Napoleon direct vent gas/propane fireplaces.

Blower Kit	Blower Only	Watts	Amps	Volts	RPM	Rot.	CFM	Blower	Blower Wheel	Bearing
<b>HB-RB58</b>	<b>HB-RB59</b>	42	0.65	115	1/1463	CCW	108	10.5"x4.3"x3.6"	65x180mm (2.6x7.1")	Ball

HB-RB58 Includes blower, mounting base, thermal switch assembly, variable speed control, mounting hardware, wiring harness - cord w/ 2-prong plug.

HB-RB59 includes blower, mounting base plate, variable speed control. Does not include mounting hardware, thermal switch or electrical assemblies.

### Napoleon, Continental, Wolf Steel

Continental GZ552 - Gas - Napoleon GZ552 - Gas

Part #	Watts	Amps	Volts	RPM	Rot.	CFM	Blower	Blower Wheel	Bearing
<b>HB-RB61</b>	42	0.65	115	1/1463	CCW	108	10.5"x4.3"x3.6"	65x180mm (2.6x7.1")	Ball

HB-RB61 blower only.



### Napoleon, Continental, Wolf Steel

EP62-1, EM3030LH186

Part #	CFM	Volts	Amps	Type	RPM	Rot.	Body	Frame	Bearing
<b>HB-RB621</b>	108	115	0.65	SP	1/1463	CCW	12.25	Skel	Ball

Includes blower, mounting base & plate, variable speed control, cord - 3 prong plug

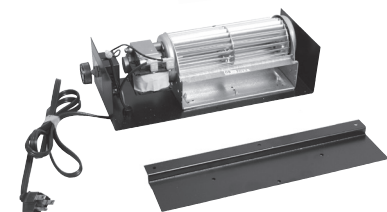

### Napoleon, Continental, Wolf Steel

Gas Fired Stove - GDS50, GDS 636

Part #	Watts	Amps	Volts	RPM	Rot.	CFM	Blower	Blower Wheel	Bearing
<b>HB-RB166</b>	53	0.92	115	1/2400	CCW	125	12.8"x4.6"x4.3"	76x101mm (3x4")	Ball

HB-RB166 blower only with mounting bracket with grommets.



**Nordica**

Nordica B150 - Blower only - Traditional 1600-2100, Rustic 1600-2100

Part #	Watts	Amps	Volts	RPM	Rot.	CFM	Blower	Blower Wheel	Bearing
<b>HB-RB166</b>	53	0.92	115	1/2400	CCW	125	12.8"x4.6"x4.3"	76x101mm (3x4")	Ball

Includes blower with mounting bracket with grommets.



**Nordica**

Part #	Watts	Amps	Volts	RPM	Rot.	CFM	Blower	Blower Wheel	Bearing
<b>HB-RB513</b>	162	1.35	115	1/2600	CW	220	17.6"x4.25"x3"	65x330mm (2.6x13.0")	Sleeve

HB-RB513 furnished with cooling fan OSE.



**Nordica**

Nordica D-100 - Blower Only - Etna-Everest 200-2500, Olympia D-100

Part #	Watts	Volts	CFM	RPM	Bearing	Impeller	Noise	Connection
<b>T8-RF235</b>	22	115	106	3000	Ball	Metal	50db (A)	Terminal



**Nordica**

Part #	Watts	Amps	Volts	RPM	Rot.	CFM	Blower	Blower Wheel	Bearing
<b>HB-RB571</b>	45	0.38	115	1/1800	CCW	73	9.8"x3.7"x3.2"	60x180mm (2.36x7.1")	Sleeve

HB-RB571 blower only.



**Nordica**

Wood Stove Blower - UE383, Fasco B24220

Part #	CFM	Amps	Volts	RPM	Rot.	Body	Type	Frame	Bearing
<b>R7-RB3</b>	100	0.35	115	1/3220	CW	5.65"	PSC/ Open	3.3"	Ball

R7-RB3 Includes intake screen guard, 3-prong plug, round discharge - square flange.



**Osburn**

Osburn FD006-1600 (Inserts), 1800, 2200, 2400 (Stoves)

Part #	Watts	Amps	Volts	RPM	Rot.	CFM	Blower	Blower Wheel	Bearing
<b>HB-RB006</b>	81	1.40	115	2/2800	CCW	125/150	12.8"x4.6"x4.3"	76x101mm (3x4")	Ball

HB-RB006 Includes blower, housing, 3-way switch - cord with three prong plug.

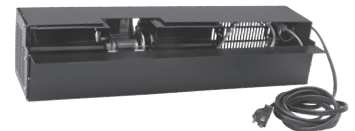

**Osburn**

Osburn KA108

Part #	Watts	Amps	Volts	RPM	Rot.	CFM	Blower	Blower Wheel	Bearing
<b>HB-RB108</b>	50	0.86	115	1/1450	CW	130	12.9"x4.3"x3.6"	65x240mm (2.6x9.4")	Ball

HB-RB108 blower includes mounting base plate with grommets.

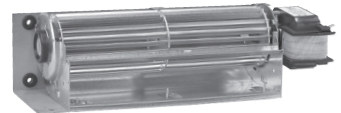

**Pacific Energy Esteem**

Pacific Energy 5053-947 (Kit), MNB.BLOW, ENCD.BLOW

Part #	Watts	Amps	Volts	RPM	Rot.	CFM	Blower	Blower Wheel	Bearing
<b>HB-RB50</b>	53	0.92	115	1/2400	CW	125	12.8"x4.6"x4.3"	76x101mm (3x4")	Ball

HB-RB50 Includes blower, mounting base w/ rubber grommets, variable speed control - cord with three prong plug.



**Pacific Energy**

Pacific Energy - WODC.BLOW / PACI 179B

Part #	CFM	Amps	Volts	RPM	Rot.	Blower	Blower Wheel	Bearing
<b>HB-RB179</b>	125	0.92	115	1/2400	CW	17.5"x4.75x4.3"	76x101mm (3x4")	Ball

HB-RB179 Includes blower, housing, variable speed control, thermal switch, Auto./Man. operation rocker switch, cord w/ 3 prong plug.



**Polaris**

Polaris PG200

Part #	Watts	Amps	Volts	RPM	Rot.	CFM	Blower	Blower Wheel	Bearing
<b>HB-RB944</b>	17	0.77	115	1/2900	CCW	105	10.3"x3.6"x3.6"	60x180mm (2.36x7.1")	Ball

HB-RB944 blower only.



**Quadra Fire**

Free Standing Woodstove Blower

Part #	Watts	Amps	Volts	RPM	Rot.	CFM	Blower	Blower Wheel	Bearing
<b>HB-RB83</b>	53	0.92	115	1/2400	CCW	125	12.8"x4.6"x4.3"	76x101mm (3x4")	Ball

HB-RB83 - Blower housing, built in speed control - 8' cord with three prong plug



# OEM Replacement



## Blowers, Motors & Fan Kits Quadra Fire

Quadra-Fire FKGAS (Stove Blower), BKGAS

Part #	Watts	Amps	Volts	RPM	CFM	Blower	Blower Wheel	Bearing
<b>HB-RB81</b>	81	0.92	115	1/2400	125	12.8"x4.5"x4.3"	76x101mm (3x4")	Ball

HB-RB81 Includes blower, housing, thermal switch assembly, speed control - cord with three prong plug.



## Regency

Regency 910-33/P, -142/P, I1100, I2100, I3100 (Wood Insert)

Part #	Watts	Amps	Volts	RPM	Rot.	CFM	Blower	Blower Wheel	Bearing
<b>HB-RB166</b>	53	0.92	115	1/2400	CCW	125	12.8"x4.6"x4.3"	76x101mm (3x4")	Ball

HB-RB166 blower, electrical leads, mounting bracket with grommets.



## Regency

Regency 846-515(Kit), 910-157/P (Blower Only), F1100, F2100, F2400M, F3100 Classic (Free Standing Wood)

Part #	Watts	Amps	Volts	RPM	Rot.	CFM	Blower	Blower Wheel	Bearing
<b>HB-RB167</b>	53	1.30	115	2/2800	CCW	125/150	12.8"x4.5"x4.3"	76x101mm (3x4")	Ball

HB-RB167 Includes blower, electrical leads, mounting bracket with grommets.



## Regency

Regency 432-917, P33, P36, P36D, P48

Part #	Watts	Amps	Volts	RPM	Rot.	CFM	Blower	Blower Wheel	Bearing
<b>HB-RB32</b>	50	0.86	115	1/1450	CW	130	12.9"x4.3"x3.6"	65x240mm	Ball

Includes blower, mounting base, speed controller, & thermal switch assemblies



## Regency

910-331/P

Part #	Watts	Amps	Volts	RPM	Rot.	CFM	Blower	Blower Wheel	Bearing
<b>HB-RB64</b>	50	0.86	115	1/1450	CW	130	12.9"x4.3"x3.6"	65x240mm (2.6x9.4")	Ball

Blower only.



## RSF

RSF - FO-FDHB5-N - Mdl. Onyx/Opel/Delta

Part #	Blower Only	CFM	Amps	Volts	RPM	Blower	Blower Wheel	Bearing
<b>HB-RB53</b>	<b>HB-RB53B</b>	225	1.30	115	1/1450	25.75"x4.3"x3.6"	65x240mm (x2)	Ball



## S.B.I.

General Replacement Wood Stove Blower

Part #	HP	Volts	Amps	Type	RPM	Rot.	CFM	Body	Frame	Bearing
<b>R7-RB33</b>	1/25	120	0.60	ECM/Open	1/2800	CW	73	6.6"	3.3"	Ball

HB-RB33 Includes intake screen guard, built-in variable speed control, 3-prong plug, round discharge - square flange.



## Security

Security UZY4 - Fan kit (Wood Fireplace)

Blower Kit	Blw. Only	Watts	Amps	Volts	RPM	Rot.	CFM	Blower	Blw. Wheel	Bearing
<b>HB-RB267</b>	<b>HB-RB67</b>	35	0.75	115	1/1800	CCW	80	12.9"x4.3"x3.6"	65x120mm	Ball

HB-RB267 Includes two blowers, instructions, mounting bases, thermal switch assembly with mounting magnets, wiring harness - cord with three prong plug.

HB-RB67 Includes one blower & mounting base plate with grommets.



## Security

Security UZY Old BIS1 & BIS2

Part #	Watts	Volts	CFM	RPM	Bearing	Impeller	Noise	Connection
<b>T8-RF235</b>	22	115	106	3000	Ball	Metal	50db (A)	Terminal



## Selkirk

45mm Blowers & Kits

Blower Kit	Blower Only	Watts	Amps	Volts	RPM	Rot.	CFM	Blower	Blower Wheel	Bearing
<b>HB-RB89</b>	<b>HB-RB85</b>	23	0.46	115	1/2050	CW	75	10.4"x3.25"x2.8"	45x180mm (1.8x7.1")	Sleeve
<b>HB-RB88</b>	<b>HB-RB87</b>	35	0.60	115	1/1900	CW	110	15.4"x3.25"x2.8"	45x300mm (1.8x11.8")	Sleeve

HB-RB89 & HB-RB88 Include blower, mounting base, thermal switch assembly, variable speed control & cord with three prong plug.

HB-RB85 & HB-RB87 Include blower & cord with three prong plug.

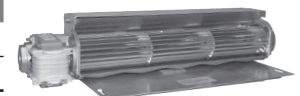

## Skytech

FK-180

Part #	CFM	Amps	Volts	RPM	Rot.	Blower	Blower Wheel	Bearing
<b>HB-RB861</b>	180	1.48	115	1/2900	CCW	12.8"x4.6"x4.3"	76x101mm (3x4")	Ball

Includes blower with magnetic mounting, thermal switch, variable speed control, cord with two prong plug.



## Valor

HB-RB555 - 555CFK Models 530, RF24, MF28  
 HB-RB755 - 755CFK Models 534, 535, 650, 738 (BV Only), 739

Blower Kit	CFM	Amps	Volts	RPM	Rot.	Body	Blower Wheel	Bearing
<b>HB-RB555</b>	67	0.46	115	1/2200	CW	7.80	45x180mm (1.8x7.1")	Sleeve
<b>HB-RB755</b>	125	0.92	115	1/2400	CCW	12.80	76x101mm (3x4")	Ball

Kits include blower, variable speed control, & thermal switch.



## Vermont Casting, Dutchwest, Stardance, CFM

Dutchwest FK26 (#2465 Direct Vent Gas Stove & #2467 Natural Vent Gas Stoves)  
 Stardance FK26 (SNV30 Natural Vent Gas Stove)

Part #	Watts	Amps	Volts	RPM	Rot.	CFM	Blower	Blower Wheel	Bearing
<b>HB-RB27</b>	53	0.92	115	1/2400	CCW	125	12.8"x4.6"x4.3"	76x101mm (3x4")	Ball

LEGAL NOTICE HB-RB27 Includes blower, mounting base & variable speed control assembly - cord with three prong plug.

RO TOM IS A REGISTERED TRADEMARK OF ALLTEMP PRODUCTS COMPANY LIMITED (ALLTEMP)

IT IS IMPORTANT TO NOTE THAT ALLTEMP IS NOT AFFILIATED WITH ANY OF THE ORIGINAL EQUIPMENT MANUFACTURERS OR THEIR BRANDS WHICH MAY BE REFERRED TO HEREIN. ALL BRAND NAMES OR TRADEMARKS USED HEREIN ARE THE PROPERTY OF THEIR RESPECTIVE OWNERS AND ALL ORIGINAL EQUIPMENT MANUFACTURERS' NAMES, NUMBERS, SYMBOLS AND DESCRIPTIONS ARE FOR CROSS REFERENCE PURPOSES ONLY. IT IS NOT IMPLIED THAT ANY PART REFERRED TO HEREIN IS THE PRODUCT OF ANY ORIGINAL EQUIPMENT MANUFACTURER, NOR ANY OF ITS ASSOCIATED BRANDS. TRADEMARK DISCLAIMER - PRODUCT NAMES, LOGOS, BRANDS, AND OTHER TRADEMARKS FEATURED WITHIN ARE THE PROPERTY OF THEIR RESPECTIVE TRADEMARK HOLDERS. THESE TRADEMARK HOLDERS ARE NOT AFFILIATED WITH ALLTEMP, OUR PRODUCTS OR OUR WEBSITE. NO ASSOCIATION BETWEEN ALLTEMP AND ANY TRADEMARK HOLDER IS EXPRESSED OR IMPLIED. NAMES, NUMBERS, SYMBOLS AND DESCRIPTIONS ARE FOR CROSS REFERENCE PURPOSES ONLY.

## UNIVERSAL

### Double Centrifugal Blower Kit

- Fits many OEM gas & wood fireplaces!
- All components feature magnets for easy installation!
- Kit includes blower, pre-assembled thermal sensor and variable speed control assembly complete with cord and three prong plug!

**MAGNETIC MOUNTING!**  
 Blower, Thermal Sensor & Speed Control



Blower Kit	Blower Only	Watts	Amps	Volts	RPM	Rot.	CFM	Blower	Blower Wheel	Bearing
<b>HB-RB38</b>	<b>HB-RB38B</b>	53	0.92	115	1/2400	CW	125	12.8"x4.7"x4.3"	76x101mm (3x4")	Ball

## UNIVERSAL

### Tangential Blower Kit

- Fits many OEM gas & wood fireplaces!
- All components feature magnets for easy installation!
- Kit includes blower, pre-assembled thermal sensor and variable speed control assembly complete with cord and three prong plug!

**MAGNETIC MOUNTING!**  
 Blower, Thermal Sensor & Speed Control



Part #	Blower Only	Watts	Amps	Volts	RPM	Rot.	CFM	Blower	Blower Wheel	Bearing
<b>HB-RB39</b>	<b>HB-RB39B</b>	50	0.86	115	1/1450	CW	130	12.9"x4.3"x3.6"	65x240mm (2.6x9.4")	Ball

Blower kit includes blower, magnetic mounting, thermal switch assembly with mounting magnets, variable speed control - cord with three prong plug.  
 Blower only includes only blower with magnetic mounting.

## Pellet Stove Gear Auger Motors

### Gear Motors

- 115 Volt • Sleeve Bearing • Single Speed • Shaded Pole • CCW Rotation

Part #	Amps	RPM	Body	Shaft	Features	Cross Reference
<b>HM-RGM450</b>	0.25	1.0	3.2"	1.1"x3/8"	Spade terminals, Inc.'s 6 mtn. bolts 14 Watts Out	Enviro EF001
<b>HM-RGM451</b>	0.19	1.0	3.0"	1"x3/8"	Spade terminals, Inc.'s 6 mtn. bolts 1.5 Watts Out	Lennox Hearth 6216, Fasco V08038AA09
<b>HM-RGM453</b>	0.19	1.0	3.2"	1.1"x3/8"	Centered spade terminals, Inc.'s 6 mtn. bolts 11 Watts Out	
<b>HM-RGM452</b>	1.26	2.0	3.0"	1"x3/8"	Bare wire leads, Inc.'s 6 mtn. bolts	Canadian Comfort Industries, Fasco V07926AAD9
<b>HM-RGM454</b>	0.73	4.0	3.2"	1.1"x3/8"	Spade terminals, Inc.'s 6 mtn. bolts 35 Watts Out	
<b>HM-RGM651</b>	1.00	7.0	3.25"	1"x1/2"	Bare wire leads, Inc.'s 4 mtn. bolts & 2" dia. fan blade, 50 Watt	EMC6216, Fasco V07959ABD9

Replacements For:

Avalon, Austroflam, Breckwell, Enviro, Earth Stove, Fasco, Lennox, Merkle-Korff Ind., National Steel Crafters, Pellet Master, Travis Ind., Whitfield (Quest), Traditions & Profile Series Stoves...

**Pellet Brush Kits Pg. 20**

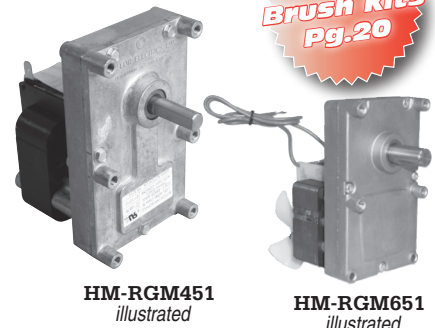

**HM-RGM451**  
illustrated

**HM-RGM651**  
illustrated



## Pellet Stove Blower Motors

### Whitfield - Quest

Whitfield - Quest 12026011, 13656011, Breckwell, Travis (Avalon & Lopi) Quadra-Fire, Fasco 7021-9129

Part #	HP	Volts	Amps	Type	RPM	Rotation	Body	Frame	Bearing
<b>HB-RBM120</b>	1/14	115	0.60	SP/ Open	1/3000	CCW	5.25"	3.3"	Sleeve

HB-RBM120 Includes 6 mounting nuts, gasket, fan blade & plug.  
Mounting - 5.75" Diameter, 5.5" Mounting Centers

### Whitfield - Convection Blower

Whitfield 12126109, Fasco 7021-7786

Part #	HP	Volts	Amps	Type	RPM	Rotation	Body	Frame	Bearing
<b>HB-RBM121</b>	1/35	115	1.50	SP/ Open	1/3000	CW	7.3"	3.3"	Sleeve

HB-RBM121 Square discharge, square flange & plug.

### Lennox - Earth Pellet Stove Blower

Lennox 15007 (Model), 8253710702 (Blower)

Part #	HP	Volts	Amps	CFM	Type	RPM	Rotation	Body	Frame	Bearing
<b>HB-RB150</b>	1/35	115	1.00	155	SP/ Open	1/1500	CW	7.4"	3.3"	Sleeve

HB-RB150 Square discharge, square flange, 2 bare wire leads & 1 plug.



## Box Frame Blowers

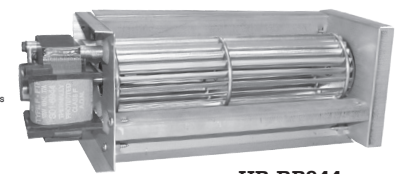
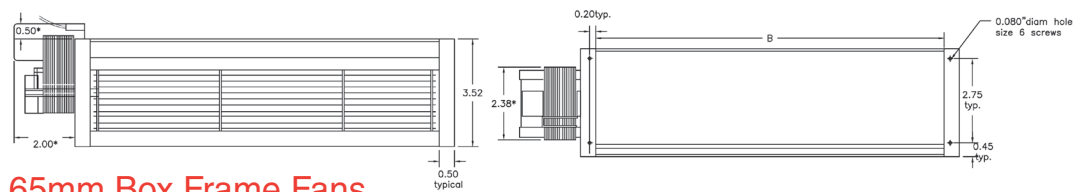

**HB-RB944**  
illustrated

### 65mm Box Frame Fans

Part #	Watts	Volts	Amps	RPM	Rotation	CFM	Bearing	Body	Wheel	B
<b>HB-RB944</b>	17	115	0.77	1/2900	CCW	105	Ball	10.3"x3.6"x3.6"	2.25"x7.13"	7.31"
<b>HB-RB939</b>	29	115	0.62	1/2800	CW	180	Ball	15.5"x3.6"x3.6"	2.25"x12.25"	12.46"
<b>HB-RB949</b>	29	115	0.97	1/2900	CCW	180	Ball	15.5"x3.6"x3.6"	2.25"x12.25"	12.46"
<b>HB-RB950</b>	29	240	0.30	1/2900	CCW	180	Ball	15.5"x3.6"x3.6"	2.25"x12.25"	12.46"

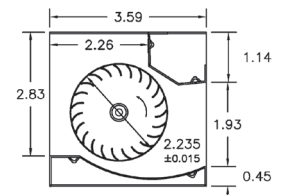

## Box Frame Blowers - Double



**HB-RB96**  
illustrated

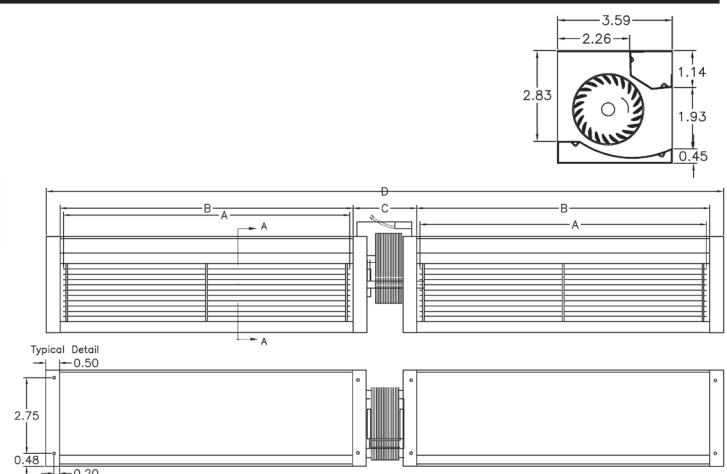

### Double Tangential Fan

Sil-Flo: Marcot Baseboard Heater, Lau T221-18 (HB-RB221)

Part #	Watts	Volts	Amps	RPM	Rotation	CFM	Bearing	Body	Frame	Wheel	B	C	D
<b>HB-RB96</b>	58	115	1.50	1/2900	CW	360	Ball	28.6"x 3.6"x3.6"	Skel.	2.25"x12.25"	12.46"	3.02"	28.61"

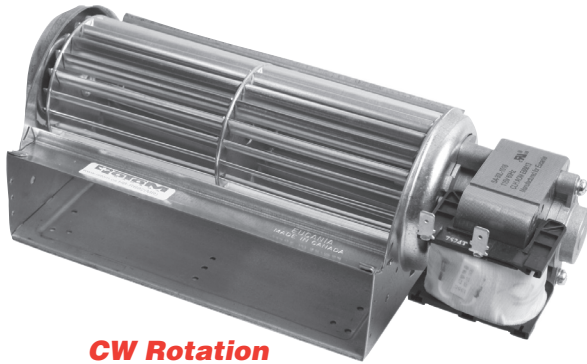

### CW Rotation

- HB-RB66 HB-RB82 *illustrated*
- HB-RB64 HB-RB69
- HB-RB611 HB-RB41
- HB-RB45

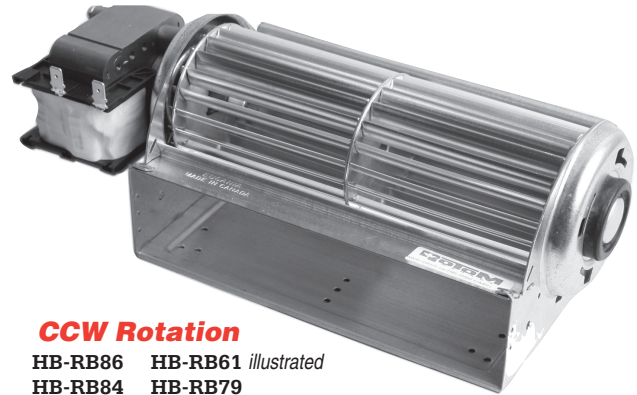

### CCW Rotation

- HB-RB86 HB-RB61 *illustrated*
- HB-RB84 HB-RB79
- HB-RB822 HB-RB42
- HB-RB46



**Telescopic Spout  
That Reaches  
Everywhere !**

**The Finest  
All-Purpose  
Industrial Oil**

**10-ZS75**

- \* 118 ml Bottle
- \* 12/ctn

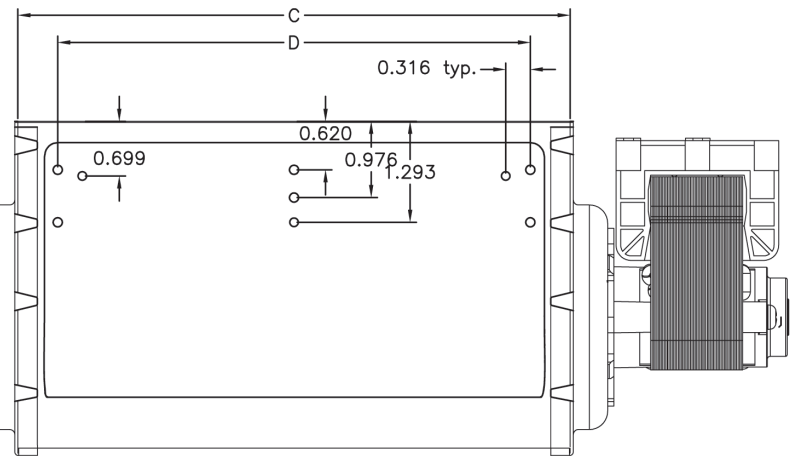
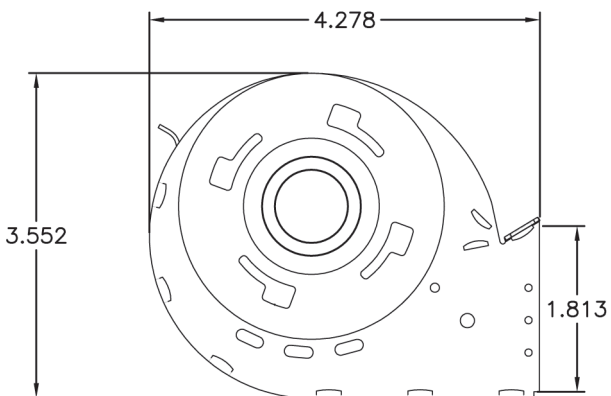
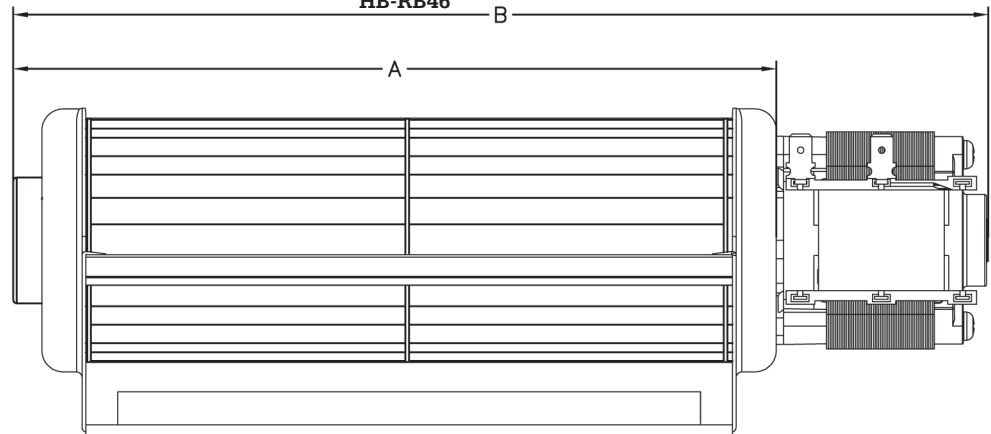

### 65mm Tangential Fans - Standard Duty

Part #		Watts	Volts	Amps	RPM	CFM	Bearing	Body	Wheel	Dimensions			
CW Rot.	CCW Rot.									A	B	C	D
HB-RB66	HB-RB86	35	115	0.75	1/1800	80	Ball	8.0x4.3x3.6"	65x120mm (2.6x4.7")	6.00"	8.32"	4.72"	3.70"
HB-RB82	HB-RB822	42	115	0.75	1/1600	110	Ball	10.5x4.3x3.6"	65x180mm (2.6x7.1")	8.36"	10.69"	7.09"	6.06"
HB-RB611	HB-RB61	42	115	0.75	1/2400	160	Ball	10.5x4.3x3.6"	65x180mm (2.6x7.1")	8.36"	10.69"	7.09"	6.06"
HB-RB64	HB-RB84	50	115	0.86	1/1450	130	Ball	12.9x4.3x3.6"	65x240mm (2.6x9.4")	10.72"	13.05"	9.45"	8.43"
HB-RB69	HB-RB79	62	115	1.10	1/1200	150	Ball	15.7x4.3x3.6"	65x300mm (2.6x11.8")	13.09"	15.72"	11.81"	10.79"

Motor on right side of blower      Motor on left side of blower

### 65mm Tangential Fans - Heavy Duty - Ball Bearing Motor & End Bearing

Part #		Watts	Volts	Amps	RPM	CFM	Bearing	Body	Wheel	Dimensions			
CW Rot.	CCW Rot.									A	B	C	D
HB-RB41	HB-RB42	54	115	0.80	2100	160	Ball	10x4.3x3.5"	65x180mm (2.6x7.1")	8.36	10.0	7.08	6.09
HB-RB45	HB-RB46	54	115	0.80	1500	140	Ball	12.6x4.3x3.5"	65x240mm (2.6x9.4")	10.12	12.6	9.45	8.43

## 80mm × 80mm × 38mm (3.15" × 3.15" × 1.5")

• Mounting Centres 71.5mm (2.82")

Part #	Watts	Volts	CFM	RPM	Bearing	Impeller	Noise	Connection	Weight
T8-RF200	10	115	32	3100	Sleeve	Metal	34db (A)	Wire Leads	420g
T8-RF201*	9	115	21	2000	Sleeve	Metal	26db (A)	Wire Leads	420g
T8-RF202*	10	230	32	3100	Ball	Metal	34db (A)	Wire Leads	420g

## 120mm × 120mm × 38mm (4.72" × 4.72" × 1.5")

• Mounting Centres 105mm (4.13")

Part #	Watts	Volts	CFM	RPM	Bearing	Impeller	Noise	Connection	Weight
T8-RF205	22	115	106	3000	Sleeve	Metal	50db (A)	Terminal	600g
T8-RF210	22	115	106	3000	Ball	Metal	50db (A)	Terminal	600g
T8-RF225	22	115	106	3000	Ball	Metal	50db (A)	Wire Leads	600g
T8-RF215	21	230	106	3000	Sleeve	Metal	50db (A)	Terminal	600g
T8-RF220	21	230	106	3000	Ball	Metal	50db (A)	Terminal	600g

## 119mm × 119mm × 38mm (4.69" × 4.69" × 1.5")

• Mounting Centres 105mm (4.13")

Part #	Watts	Volts	CFM	RPM	Bearing	Impeller	Noise	Connection	Weight
T8-RF230	12	115	106	3100	Sleeve	Plastic	46db (A)	Terminal	530g
T8-RF235	12	115	106	3100	Ball	Plastic	46db (A)	Terminal	530g
T8-RF236*	15	230	106	3100	Sleeve	Plastic	46db (A)	Terminal	530g
T8-RF237*	15	230	106	3100	Ball	Plastic	46db (A)	Terminal	530g

## 150mm × 150mm × 55mm (5.9" × 5.9" × 2.2")

• Mounting Centres 162mm (6.38")

Part #	Watts	Volts	CFM	RPM	Bearing	Impeller	Noise	Connection	Weight
T8-RF240	42	115	230	3400	Ball	Plastic	53db (A)	Wire Leads	1kg
T8-RF245	40	230	230	3400	Ball	Plastic	53db (A)	Wire Leads	1kg

## 150mm × 172mm × 38mm (5.9" × 6.7" × 1.5")

• Mounting Centres 162mm (6.38")

Part #	Watts	Volts	CFM	RPM	Bearing	Impeller	Noise	Connection	Weight
T8-RF247*	28	115	212	3400	Ball	Plastic	58db (A)	Terminal	720g
T8-RF248*	26	230	212	3400	Ball	Plastic	58db (A)	Terminal	720g

## 180mm × 180mm × 90mm (7.1" × 7.1" × 3.5")

• Mounting Centres 152.7mm (6.01")

Part #	Watts	Volts	CFM	RPM	Bearing	Impeller	Noise	Connection	Weight
T8-RF249*	72	115	460	3400	Ball	Plastic	59db (A)	Screw	2.2kg

## 254mm × 254mm × 89mm (10" × 10" × 3.5")

• Mounting Centres 247mm (9.72")

Part #	Watts	Volts	CFM	RPM	Bearing	Impeller	Noise	Connection	Weight
T8-RF250	35	115	547	1650	Ball	Plastic	55db (A)	Terminal	1.9kg
T8-RF255	33	230	547	1650	Ball	Plastic	55db (A)	Terminal	1.9kg

### Metal Fan Guards

Mounting: Screw Holes

Part #	Size
T8-CFG-60M	66mm
T8-CFG-80M	80mm
T8-CFG-92M	92mm
T8-CFG-120M	120mm
T8-CFG-150M	150mm
T8-CFG-254M	254mm

### Plastic Fan Guards

Mounting: Plastic Tabs

Part #	Size
T8-CFG-80P	80mm
T8-CFG-120P	120mm

Note: T8-CFG-80M, 120M, 150M are also available in black. \*



T8-CFC-T24 illustrated

### Axial Fan Features:

- Die-cast Aluminum Housing
- Shaded Pole Motor
- Impedance Protection
- CSA & UL Approved.
- Operating Temp. Range -10°C to 70°C
- Metal or Plastic Impellers
- Sleeve or Ball Bearings



T8-RF200 illustrated



T8-RF200 illustrated



T8-RF210 illustrated



T8-RF230 illustrated



T8-RF245 illustrated

### Axial AC Power Cords

**Bare Wire** - 2 Pin molded connection to bare wire leads.

**Plug** - 2 Pin molded connection to 2 prong plug.

Bare Wire	Description	Plug
T8-CFC-T24	60.96cm (24") Cord	T8-CFC-T24P
-	121.92cm (48") Cord	T8-CFC-T48P
T8-CFC-T72	182.88cm (72") Cord	T8-CFC-T72P



Part #	CFM	Spd/RPM	Volts	Amps	Rot.	Type	Const.	Bearing	Cross
R7-RB440	50	1/3080	115	0.25	CW	PSC	Open	Ball	Grainger 1TDN7, 4C440
R7-RB55	55	1/1550	115	0.25	CW	SP	Open	Sleeve	AO Smith 12
R7-RB663	60	1/3000	115	0.60	CCW	SP	T.E.	Sleeve	AO Smith 9444
R7-RB662	60	1/3000	208/240	0.30	CCW	SP	Open	Sleeve	AO SMITH 9443, FASCO 50747-D230, GRAINGER 2C014
R7-RB661	60	1/3000	115	0.50	CCW	SP	Open	Sleeve	AO SMITH 9461, FASCO 50747-D500
R7-RB60	60	1/3200	115	0.80	CW	SP	Open	Sleeve	AO SMITH 9470, FASCO 50747-D401
R7-RB70	70	1/3000	115	0.50	CCW	SP	Open	Sleeve	AO Smith 989
R7-RB33	73	1/2800	115	0.60	CW	ECM	Open	Ball	Newmac 204001 EB3 w/ Variable Spd Switch
R7-RB665	75	1/3020	115	0.45	CCW	PSC	Open	Ball	AO SMITH 9462, FASCO 50748-D500, GRAINGER 4C443
R7-RB885	85	2/2800	115	0.65	CW	SP	Open	Sleeve	AO SMITH 414
R7-RB90	90	1/3000	115	1.00	CW	SP	Open	Sleeve	AO SMITH 13
R7-RB991	90	1/3000	115	1.00	CW	SP	Open	Sleeve	AO SMITH 383
R7-RB4	100	1/3220	115	0.34	CW	PSC	T.E.	Ball	Franklin 76012, 80042, Electrohome EB4
R7-RB3	100	1/3220	115	0.34	CW	PSC	Open	Ball	Fasco B24220
R7-RB2	100	1/1550	115	0.47	CW	SP	T.E.	Sleeve	Franklin 76002, 80978, Electrohome EB2

Flange Mounting Dimensions Available on Page 21 & 22



R7-RB54



R7-RB120

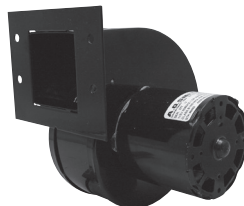

R7-RB141

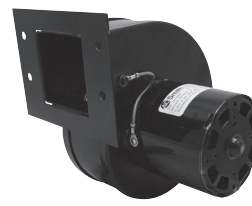

R7-RB142

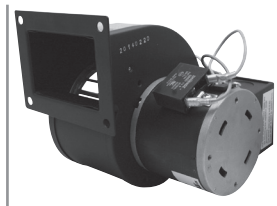

R7-RB446

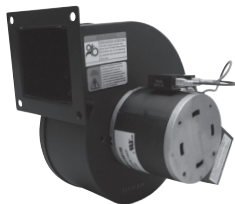

R7-RB155



R7-RB151



R7-RB160



R7-RB165



R7-RB180



R7-RB1



R7-RB312



R7-RB245

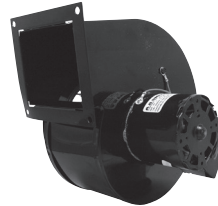

R7-RB265

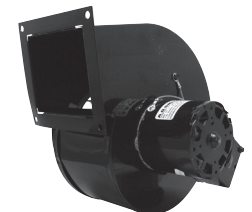

R7-RB266

Part #	CFM	Spd/RPM	Volts	Amps	Rot.	Type	Const.	Bearing	Cross
R7-RB54	100	1/3450	115	0.43	CW	PSC	T.E.	Ball	Easy Radiant
R7-RB120	120	1/3100	115	0.80	CW	SP	Open	Sleeve	AO Smith 9445
R7-RB141	140	1/3000	115	1.00	CCW	SP	Open	Sleeve	AO Smith 9492, Fasco 50752-D500, GRAINGER 4C442
R7-RB142	140	1/3000	208/240	0.50	CCW	SP	Open	Sleeve	AO Smith 9493, Fasco 50752-D230, Grainger 2C915
R7-RB446	146	1/3120	115	0.75	CCW	PSC	Open	Ball	Grainger 4C446, 1TDP7, Fasco 7021-3469, A166
R7-RB155	148	1/2480	115	0.75	CCW	PSC	T.E.	Ball	Grainger 1TDR6, 4C006, Fasco 7021-4933
R7-RB151	150	1/3000	115	1.10	CCW	SP	Open	Sleeve	AO Smith 9483
R7-RB160	160	1/1595	115	1.20	CCW	SP	Open	Sleeve	AO Smith 458
R7-RB165	165	1/3550	115	0.65	CCW	PSC	Open	Ball	<b>NEW!</b>
R7-RB180	180	3/1500	115	2.00	CCW	SP	Open	Sleeve	AO Smith 9471, Fasco B47120, Grainger 4C754
R7-RB1	200	1/2700	115	1.10	CW	SP	Open	Sleeve	Franklin 80748, 80981, Electrohome EB1
R7-RB312	222	1/2750	115	0.60	CCW	PSC	Open	Ball	Grainger 1TDU8, 4C826, Fasco A212, 70219025
R7-RB245	245	1/1550	115	1.50	CCW	SP	Open	Sleeve	AMU45, Airdex
R7-RB265	265	1/1640	115	0.77	CCW	PSC	Open	Ball	Franklin 80224, U.E.459, Fasco B45227
R7-RB266	265	1/1650	230	1.90	CCW	SP	Open	Sleeve	AO Smith 9411, Fasco B45227-2, Grainger 4C869

Flange Mounting Dimensions Available on Page 21 & 22



Part #	CFM	Spd/RPM	Volts	Amps	Rot.	Type	Const.	Bearing	Cross
R7-RB447	273	1/1640	115	0.77	CCW	PSC	Open	Ball	Grainger 4C447, 1TDR3
R7-RB938	287	1/3280	115	1.30	CCW	PSC	Open	Ball	ProFab 814320, Aspen, Emphyre, Fasco 70625938
R7-RB320	320	1/1500	115	1.30	CW	SP	Open	Sleeve	AO Smith 9486, Fasco 50756-D500
R7-RB326	326	1/1600	115	1.10	CCW	PSC	Open	Ball	AO Smith 9467, Grainger 4C943
R7-RB350	350	2/1570	115	3.00	CCW	SP	Open	Sleeve	AO Smith 9466, Grainger 4C444
R7-RB428	428/ 293	2/1500 /1085	115	1.1/ 0.85	CW	PSC	Open	Ball	NEW - GRAINGER 1TDT6,4C565
R7-RB462	460	1/1550	230	1.80	CW	SP	Open	Sleeve	AO Smith 9412, Grainger 5C507
R7-RB465	465	1/1560	115	1.30	CW	PSC	Open	Ball	Franklin 80546, U.E.460, Fasco B45267, Grainger 4C448
R7-RB495	495	1/1570	115	3.80	CCW	SP	Open	Sleeve	AO Smith 9465
R7-RB500	500	2/1550	115	3.50	CCW	SP	Open	Sleeve	AO Smith 9491, Fasco 50769-D500
R7-RB445	549	1/1430	115	2.20	CCW	PSC	Open	Ball	Grainger 1TDT2, 4C445, 4YJ32
R7-RB760	797	2/1350	115	3.30	CW	PSC	Open	Ball	AO Smith 9459, Grainger 5C508
R7-RB965	965	1/1080	115	3.50	CCW	PSC	Open	Ball	Grainger 1TDT5
R7-RB1000	1000	2/1100	115/230	4.00	CCW	PSC	Open	Sleeve	AO Smith 9477, Fasco A1000
R7-RB1600	1638	4/1085	115	6.90	CCW	PSC	Open	Ball	Grainger 1XJX9

Flange Mounting Dimensions Available on Page 21 & 22

## In-Line Air Duct Booster Fans

### Air Duct Booster

Designed to be installed at any angle in the branch duct of under-ventilated rooms to increase either hot or cool air flow supply. One year limited warranty.



### Control Options

#### Manual Control

- 115V Source - continuous operation.
- 115V Switch - manual ON/ OFF ctrl.

#### Automatic Control

- Wire to furnace fan.
- Wire to fan switch.
- Wire to a sail switch.
- Wire to a pressure switch.
- Wire to thermostat.



T9-DB68 Illustrated

### Standard Air Duct Boosters



Part #	Part #		Description	Max Boosted CFM	Free Air CFM	Watts	Amps	dBA	Blade	Housing Length
	No Cord	Cord								
T9-DB68	-	-	6" - 8" Universal Round	250	160	30	0.35	50	Polycarbonate	4" x 11"
T9-DB6-2CR	-	-	6" Rnd Double Crimp	250	160	30	0.35	50	Polycarbonate	8"
-	T9-DB204C	-	4" Round	80	40	30	0.30	52	Polycarbonate	6"
-	T9-DB205C	-	5" Round	225	140	30	0.35	51	Polycarbonate	6"
-	T9-DB206C	-	6" Round	250	160	30	0.35	50	Polycarbonate	6"
-	T9-DB208C	-	8" Round	500	210	60	0.75	54	Polycarbonate	8"
-	T9-DB210C	-	10" Round	650	300	120	1.50	55	Aluminium	8"
-	T9-DB212C	-	12" Round	800	650	120	1.50	55	Aluminium	8"



T9-DB6 Illustrated

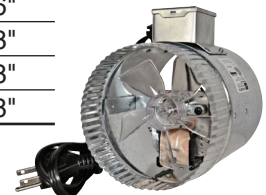

T9-DB205-CRD Illustrated

### Two Speed Air Duct Boosters



Part #	Description	Max Boosted CFM	Free Air CFM	Watts	Amps	dBA	Blade
T9-DB6-2	6" Round 2 Speed	200/300	160/180	30	0.35	50/52	Polycarbonate
T9-DB8-2	8" Round 2 Speed	500/600	210/250	60	0.85	50/55	Polycarbonate
T9-DB10-2	10" Round 2 Speed	650/900	300/460	135	1.70	56/59	Aluminium



T9-DB5-2 Illustrated

### 4-Pole Duct Boosters

Designed for larger ducts requiring commercial grade power and performance.



Part #	Description	Max Boosted CFM	Free Air CFM	Watts	Amps	dBA	Blade
T9-DB124	12" Round	1160	700	120	1.00	61	Aluminium
T9-DB144	14" Round	1580	900	120	1.00	61	Aluminium
T9-DB164	16" Round	1760	1100	120	1.00	54	Aluminium



4-Pole Duct Booster Illustrated

## Motorized Duct Dampers

### Motorized Dampers



Normally Open Part #	Normally Closed Part #	Duct Dia.	Weight
T9-MD6-NO	T9-MD6-NC	6"	3.5
T9-MD8-NO	T9-MD8-NC	8"	4.0
T9-MD10-NO	T9-MD10-NC	10"	5.0
T9-MD12-NO	T9-MD12-NC	12"	6.0

### Features

- Available in normally open or normally closed 5", 6", 7", 8", 10" and 12" duct diameters.
- 8" Housing lengths.
- 24VAC, 0.25 amps.
- 100% Shut off available.
- 3 Year limited warranty.

### Zone Control

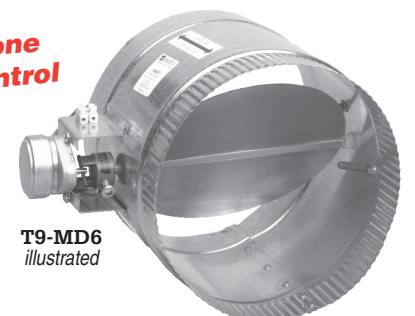

T9-MD6 Illustrated

### ThruWall Room To Room Fans

The T9-TW8-2 and T9-TW208 ThruWall™ fans easily install in an interior wall to move heated or cooled air from one adjoining room to another, providing year round comfort.

- Ultra quiet operation.
- White polymeric grills can be painted to match decor.
- Telescoping housing (Galvanized steel ) installs in frame walls from 3½" to 6½" thick.
- 10' Grounded cord(T9-TW8-2)
- Bare Wire Leads (T9-Tw208)



T9-TW8-2



T9-TW208

**Direction Airflow!  
360° Rotating Grill**

### ThruWall Fans

Part #	Features	Description	Volts	Amps	CFM	dBa	Weight
<b>T9-TW8-2</b>	• 3 Position, 2 Speed switch	Grill 9.75" Housing 7 5/8" dia.	115	0.75	160 CFM low spd. 200 CFM high spd.	High: 55 Low: 49	5.0 lbs.
<b>T9-TW208</b>	• Built-in solid state speed control allows for fan speed & sound level control. • 360° Rotating grill allows airflow direction to be changed.	Front: 12.5"×10" Back: 9.75" dia. Housing: 8" dia.	115	0.75	40 CFM low spd. 90 CFM high spd.	High: 55 Low: 49	5.0 lbs.

60 Hz., Thermally protected, Class B insulation.

### Door Frame Fan

#### Entreair® Door Frame Fan

The T9-DF100 is a safe, efficient and effective way to gently circulate warm or cool air from room to room.

#### Door Frame Fan

Part #	Description	Volts	Amps	CFM	Weight
<b>T9-DF100</b>	7" Grill diameter.	115	0.35	100 CFM.	2.0 lbs.

60 Hz., Thermally protected, Class B insulation.

- Quiet operation.
- Simple installation.
- In-line ON/OFF power switch.
- 10' Cord.
- Patented design.

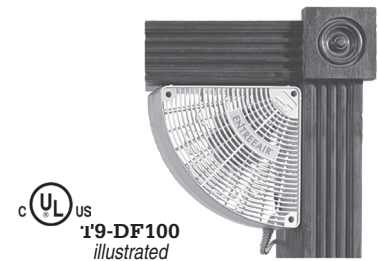

cUL<sup>US</sup>  
T9-DF100  
illustrated

### Register Air Boosters

Register Boosters™ increase airflow to under performing registers improving comfort to rooms that are too hot or too cold.

- Saves energy and money
- Engineered for maximum airflow
- Low voltage – safe for children and pets
- Works automatically with forced air systems
- 12 month limited warranty

#### Equalizer® Register Air Booster

Part #	Dimensions	Volts	Amps	Weight
<b>T9-EQ2</b>	12" x 6-¼" x 3¼"	115	0.35	2.25 lbs.

60 Hz., Thermally protected, Class B insulation.

**T9-EQ2**  
Manual - On/Off  
Auto - Heat/Cool  
(Adjustable thermostat & sensitivity differential)

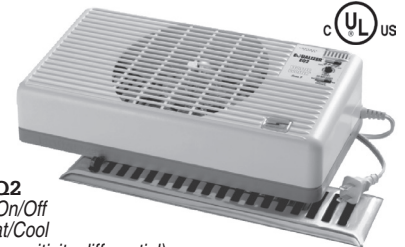

#### Flush Fit™ Register Air Booster

Part #	CFM	Watts	Volts	Colour
<b>T9-HC500-W</b>	85	15	115	White
<b>T9-HC500-B</b>	85	15	115	Brown

- Fits 4"x10" Floor and wall openings
- Available (not Included) adapter plate for: 4"x12", 6"x10" & 6"x12"

Adapter plate  
White - T9-HC5PL1-W  
Brown - T9-HC5PL1-B



### Duct Thermostat

#### Plug-In Duct Stat

The T9-DS45110 duct stat simplifies installation of in-line duct booster fans by eliminating electrical connections at the furnace.

- Economical and reliable automatic on/off control for in-line duct booster fans.
- Mounts on duct or wall to control ambient room temperature.
- Adjustable temperature range: 45° F (7° C) to 110° F (43° C) and differential.
- 6' Grounded cord.
- Year round use, ON/ OFF, AUTO heating and AUTO cooling .
- Controls various devices, including alarms, heat lamps, lights, louvers, etc.

#### Plug-In Switch - Thermostatically Controlled

Part #	Description	Volts	Dimensions	Weight
<b>T9-DS45110</b>	5 Amp maximum load (replaceable 5A fuse).	115	5.50" x 3.25" x 2.25"	1.25 lbs.

60 Hz.

cUL<sup>US</sup>



**T9-DS45110**  
illustrated



# Speed Controls & Switches



## Speed Controls



Complete with control, knob, face plate & hardware.



**HB-RB38-1**  
Speed Control Assembly



**HB-RB168-1**  
Variable Speed Control

## Motor Speed Controls

Complete with control, knob, face plate & hardware.

Part #	Volts	Amps	Description
<b>92-A8301</b>	120	2.5	Std. Ctrl Kit
<b>92-A8301-1</b>	120	2.5	No Face Plate
<b>92-A8303</b>	120	5	Std. Ctrl Kit
<b>92-A8303-1</b>	120	5	No Face Plate
<b>92-A8305</b>	120	10	W/ Heat Sink
<b>92-A8306</b>	120	15	W/ Heat Sink

Part #	Amps	Description
<b>HB-RB38-1</b>	3.0	Magnetically Mounted Speed Control & Thermal Switch Assembly
<b>HB-RB168-1</b>	3.0	Variable Speed Control

## Rocker Switches - Snap-in Mount

Type	Part #	Colour	Function	Amps	1/4" Spades	Fig.
Mini	<b>29-159-1</b>	Black	2 - On / Off	15	3	1
	<b>29-159-3</b>	Black	2 - On / Off	10	2	2
	<b>29-159-5</b>	Black	3 - On / Off / On	10	3	2

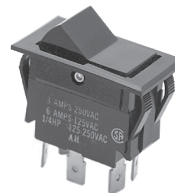

Fig. 3

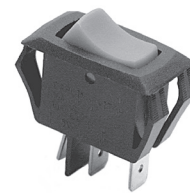

Fig. 1

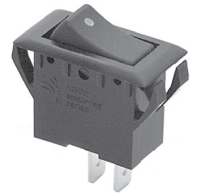
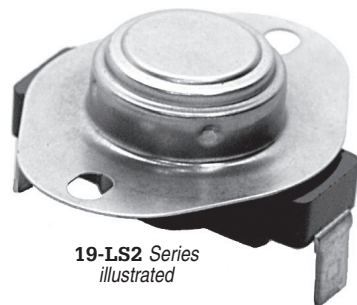

Fig. 2

## Limit Switches

### Limit Switch Nomenclature

- L** Limit - Open on rise
- S** Switch
- 2** Number of terminals
- 110** Opening temperature



19-LS2 Series  
illustrated

### Limit Switches

- 25 Amps, 240 Volt
- 2 Terminal

Part #	Part #
<b>19-LS2-120</b>	<b>19-LS2-190</b>
<b>19-LS2-135</b>	<b>19-LS2-200</b>
<b>19-LS2-140</b>	<b>19-LS2-200F</b>
<b>19-LS2-145</b>	<b>19-LS2-240</b>
<b>19-LS2-150</b>	<b>19-LS2-250</b>
<b>19-LS2-160</b>	<b>19-LS2-275</b>
<b>19-LS2-165</b>	<b>19-LS2-290</b>
<b>19-LS2-180</b>	<b>19-LS2-320</b>

## Fan Switches

### Fan Switch Nomenclature

- F** Fan - Close on rise
- S** Switch
- 2** Number of terminals
- 110** Closing temperature

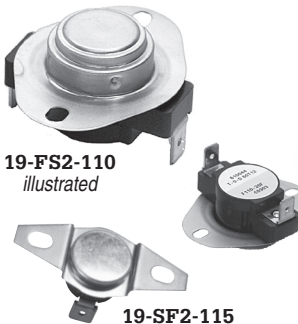

19-FS2-110  
illustrated

19-SF2-115

### Two Terminal Fan Switches

- 3/4" standard discs.

Part #	Closing Temp.
<b>19-SF2-115*</b>	43°C (110°F)
<b>19-FS2-110</b>	43°C (110°F)
<b>19-FS2-120</b>	49°C (120°F)
<b>19-FS2-130</b>	54°C (130°F)
<b>19-FS2-160</b>	71°C (160°F)
<b>19-FS2-200</b>	93°C (200°F)

\* 1/2" disc

## Fireplace Kit Accessories

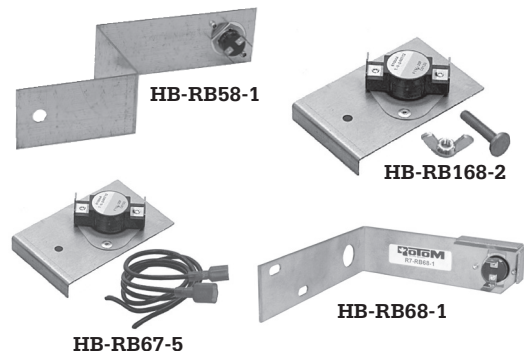

HB-RB58-1

HB-RB168-2

HB-RB67-5

HB-RB68-1



HB-RB67-3

HB-RB67-1 (One Blower)  
HB-RB67-2 (Two Blower)

## Thermal Switch Assemblies

Part #	Description
<b>HB-RB58-1</b>	Thermal Switch Assembly.
<b>HB-RB168-2</b>	Thermal Switch Assembly.
<b>HB-RB67-3</b>	Magnetic Thermal Switch Assembly.
<b>HB-RB67-5</b>	Thermal Switch Assembly & Wiring.
<b>HB-RB68-1</b>	Thermal Switch Assembly.
<b>HB-RB67-1</b>	Magnetic Thermal Switch & Wiring
<b>HB-RB67-2</b>	Harness Assembly For 1 or 2 Blowers.

Note : All switches are 43°C (110°F)

## Forged Gas Ball Valves

- Brass or plated outdoor.
- Yellow lever handle.
- 600 WOG full port.



Brass Indoor	Plated Outdoor	Description	Case Qty.
<b>06-FGV38</b>	<b>06-FGV38P</b>	3/8" FNPT x 3/8" FNPT	5
<b>06-FGV12</b>	<b>06-FGV12P</b>	1/2" FNPT x 1/2" FNPT	5
<b>06-FGV34</b>	<b>06-FGV34P</b>	3/4" FNPT x 3/4" FNPT	5
<b>06-FGV1</b>	<b>06-FGV1P</b>	1" FNPT x 1" FNPT	2
-	<b>06-FGV114P</b>	1 1/4" FNPT x 1 1/4" FNPT	2
<b>06-FGV112</b>	<b>06-FGV112P</b>	1 1/2" FNPT x 1 1/2" FNPT	2
-	<b>06-FGV2P</b>	2" FNPT x 2" FNPT	2

## Fireplace Forged Gas Ball Valves

- Brass ball valves.
- Red wing handle.
- 600 WOG.



Part #	Description	Case Qty.
<b>06-FP1238</b>	1/2" FNPT x 3/8" Male flare.	10
<b>06-FP1212</b>	1/2" FNPT x 1/2" Male flare.	10
<b>06-FP3458</b>	3/4" FNPT x 5/8" Male flare.	10

## Appliance Forged Gas Ball Valves

- Brass ball valves.
- Red wing handle.
- 600 WOG.

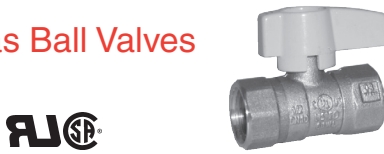

Part #	Description	Case Qty.
<b>06-GWH12</b>	1/2" FNPT x 1/2" FNPT, 3/8" port.	10
<b>06-GWH34</b>	3/4" FNPT x 3/4" FNPT, 1/2" port.	10

## Appliance Forged Gas Ball Valves

- Brass ball valves.
- Yellow flat head.
- 600 WOG.



Part #	Description	Case Qty.
<b>06-FHGV12</b>	1/2" FNPT x 1/2" FNPT, 3/8" port.	12
<b>06-FHGV34</b>	3/4" FNPT x 3/4" FNPT, 1/2" port.	12

## Boiler Drain Valves

### Forged Boiler Gate Valve

- Brass drain valve.
- Green handle.



Part #	Description	Case Qty.
<b>06-BGV12</b>	1/2" MNPT x Hose.	5
<b>06-BGV34</b>	3/4" MNPT x Hose.	5

## Water Valves

### Brass Welded Ball Valves

- Full Port.
- Female sweat connection.
- 600 WOG.
- Green lever handle.



Part #	Description	Case Qty.
<b>06-SWV12</b>	1/2" Sweat x 1/2" Sweat.	5
<b>06-SWV34</b>	3/4" Sweat x 3/4" Sweat.	5

## Silicone

### Features :

- NSF Approved • 100% Silicone • 100% RTV

### 302 (GP) General Purpose

- Available in multiple colours
- The ideal multiple purpose silicone sealant for all weather applications



Part #	Colour	Size (ml/oz)	Cs. Qty
<b>83-30281</b>	White	83/2.8(squeeze tube)	12
<b>83-30280</b>	Clear	83/2.8(squeeze tube)	12
<b>83-30283</b>	Black	83/2.8(squeeze tube)	12
<b>83-30201</b>	White	300/10.15	12
<b>83-30200</b>	Clear	300/10.15	12
<b>83-30202</b>	Aluminium	300/10.15	12
<b>83-30203</b>	Black	300/10.15	12
<b>83-30205</b>	Almond	300/10.15	12

### 302 (HT) High Temperature

- Withstands temperatures of 260°C(500°F) constant and 316°C(600°F) intermittent
- An ideal silicone for extreme temperature applications



Part #	Colour	Size (ml/oz)	Cs. Qty
<b>83-30289</b>	Red- HT	83/2.8 (Squeeze Tube)	12
<b>83-30293</b>	Black-HT	83/2.8 (Squeeze Tube)	12
<b>83-30209</b>	Red-HT	300/10.15	12
<b>83-30213</b>	Black-HT	300/10.15	12

## Epoxy Putty Sticks



Part #	Description	Size	Case Qty
12-451070-24	Fast Steel	3.5"	24
12-457070-24	Quik Aluminium	3.5"	24
12-462570-24	Quik Copper	3.5"	24
12-470570-24	Aquamend	3.5"	24
12-475570-24	QuickPlastic	3.5"	24

## Caulking Guns

### 113 Series

- Economy grade
- 310ml/10.15oz
- Clean out tool on barrel



15-CG000113

### 138 Series

- Professional grade
- 310ml/10.15oz
- Clean out tool on handle



15-CG000138

## Shop Rags

### Medium Duty Service & Shop Rags

Coloured rags, similar to balbriggan or Polo cotton T-shirt material.

Part #	Description	Weight
13-536-10	10 lbs. service size pack.	4.5 kg (10 lbs)

Additional materials and sizes available upon request

### Medium Duty

- Low cost, no lint, light weight general purpose shop rags. A good general purpose, medium quality wiper at a relatively low cost.



## Chimney & Flue Cleaning Brushes

### Chimney & Flue Brushes

Chimney/ flue cleaning brushes are available in wire for cleaning ceramic flues and chimneys, and poly for cleaning metal flues and chimneys. Choose from a complete range of standard sizes and shapes with 1/4" NPT connectors. Heavy-duty brushes are offered with 3/8" NPT connectors.

## MILL-ROSE

### Wire Chimney & Flue Brushes

- 1/4" NPT.

Part #	Description
61-30600	6" Round
61-30700	7" Round
61-30800	8" Round
61-30900	9" Round
61-31000	10" Round
61-31200	12" Round
61-30606	6" x 6" Square
61-30707	7" x 7" Square
61-30808	8" x 8" Square
61-31010	10" x 10" Square
61-31006	10" x 6" Rectangular
61-31008	10" x 8" Rectangular
61-31107	11" x 7" Rectangular
61-31208	12" x 8" Rectangular

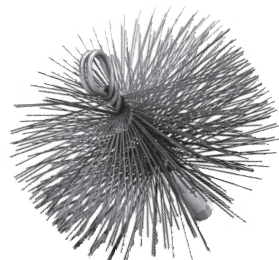

61-30600  
illustrated



Standard  
Packaging

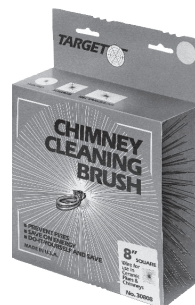

Heavy-Duty Wire  
Chimney Brushes

### Wire Chimney & Flue Brushes

Heavy-duty wire chimney brushes are designed for professional trade applications.

- Brushes 3/8" NPT.

Part #	Description
61-30601	6" Round
61-30801	8" Round
61-31001	10" Round
61-31401	14" Round
61-30708	7" x 7" Square
61-30809	8" x 8" Square
61-31011	10" x 10" Square
61-31108	11" x 7" Rectangle
61-31205	12" x 8" Rectangle
61-31213	12" x 12" Square

### Poly Chimney & Flue Brushes

- 1/4" NPT.

Part #	Description
61-33110	5" Round
61-33140	6" Round
61-33170	7" Round
61-33190	8" Round
61-33210	12" Round
61-33150	6" x 6" Square
61-33200	8" x 8" Square

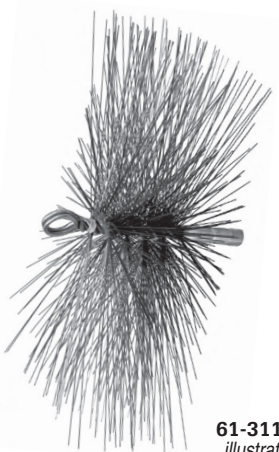

61-31107  
illustrated

### Chimney Liner Brushes

- 3/8" NPT, Round, 0.40" Crimped Poly Fill.

Part #	Description	Part #	Description
61-83491	5" Dia. poly	61-83541	8" Dia. poly
61-83501	6" Dia. poly	61-83561	9" Dia. poly
61-83521	7" Dia. poly	61-83581	10" Dia. poly



61-83521  
illustrated

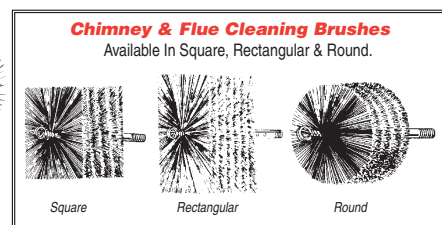

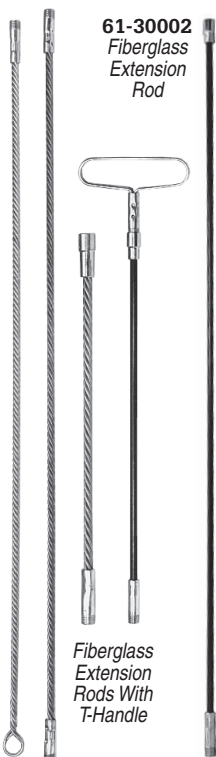

### Extension Rods Flue Boiler & Chimney

Flexible, self-connecting fiberglass or twisted wire extension rods with self-connecting 1/4" NPT nipples are available in three convenient lengths; 3', 4' & 6'.

#### Flue Boiler & Chimney Extension Rods

- Fiberglass/ Steel & Twisted Wire
- 1/4" NPT 0.34 diameter (fiberglass)

Part #	Description	Length
61-30002	Fiberglass	3'
61-30021	Fiberglass	4'
61-30022	Fiberglass W/ T-Handle (6 pk.)	4'
61-30023	Fiberglass (24pk)	4'
61-30061	Fiberglass	6'
61-30071	Fiberglass (24pk.)	6'
61-30003	Twisted Wire W/ loop handle	3'
61-30007	Twisted Wire	3'
61-30009	Twisted Wire (24/pk.)	3'
61-30031	Twisted Wire	4'
61-30033	Twisted Wire (24/pk.)	4'
61-30073	Twisted Wire (24/pk.)	6'

- 3/8" NPT self-connect 0.44 diameter.

61-30035	Fiberglass - Heavy Duty	4'
61-30065	Fiberglass - Heavy Duty	6'

#### T-Extension Rod Handle

- Used with 1/4" NPT fiberglass or steel extension rods.

Part #	Description
61-70766	Steel Construction: 4" x 2 1/2"

Twisted Wire  
Extension  
Rods



Fiberglass Pellet Stove  
Extension Rod

Fiberglass  
Pellet Stove  
Extension Rod  
With T-Handle

#### Pellet Stove Flue Extension Rods

- Fiberglass
- 5/16"-18 male/female thread.

Part #	Description	Length
61-65010	Fiberglass	2'
61-65015	Fiberglass	3'
61-65000	Fiberglass W/ T-handle.	3'
61-65016	Fiberglass	4'
61-65019	Fiberglass - Display Package W/ T-handle (6/pk).	4'
61-65017	Fiberglass	6'
61-65001	T-handle only: 1/2" x 3", 5/16" -18 male/ female thread.	-
61-65009	Rod/ brush adapter 5/16-18 to 1/4-20 thread.	-

#### Pellet Stove Flexible Connector

- Designed for pellet stove brush extension rods.
- Attaches to extension rods for 90° bends.

Part #	Description
61-70721	10 3/4" OAL, 5/16"-18 spring connector.
61-70722	13" OAL, std. rod, 1/4" NPT.

## Pellet Stove Flue Brushes

### Pellet Stove Brushes

Fibre brushes work best for soot removal in pellet stove flues, while stainless steel brushes are more suitable for creosote removal. Brushes and flexible extension rods are designed to negotiate 90° joints in most vent and flues, many cases without disassembly.

### Pellet Stove Brushes

- 1/4" - 20 male/ female thread.
- POP packaged.

Part #	Description
61-84352	3" dia. stainless steel wire
61-84332	3" dia. fibre
61-84372	4" dia. stainless steel wire
61-84333	4" dia. fibre
61-84334	4" dia. fibre pellet stove brush. 12' flexible extension rod.
61-84380	6" dia. fibre, 1/4-20 coupling
61-84385	8" dia. fibre, 1/4-20 coupling



### Pellet Stove Vent Cleaning Brushes

- 5/16"-18 female thread.

Part #	Description
61-84331	2" Dia. fibre
61-84351	3" Dia. fibre
61-84371	4" Dia. fibre

## Maintenance Brushes

### Scratch Brushes

- Oil tempered, carbon steel fill wire.
- Extra deep wire staple.
- Hard wooden handles.

### Scratch Brushes

Part #	Block Size	Handle Type	Rows	Brush Trim
61-70550	14" x 1 1/8"	Bent	4 x 18	1 3/16"
61-70606	14" x 1"	Bent	3 x 19	1 3/16"
61-70570	10" x 1 1/8"	Shoe	4 x 16	1 3/16"



# Blower Flange Dimensions



Part #	Type A				Type B			Type C							Type D				Type E			
	A	B	C	D	E	F	G	H	I	J	K	L	M	N	O	P	Q	R	S	T	U	
R7-RB1	3.00"	2.30"	3.00"	2.30"	-	-	-	-	-	-	-	-	-	-	-	-	-	-	-	-	-	
R7-RB2	3.00"	2.30"	3.00"	2.30"	-	-	-	-	-	-	-	-	-	-	-	-	-	-	-	-	-	
R7-RB3	4.60"	3.90"	3.50"	2.80"	-	-	-	-	-	-	-	-	-	-	-	-	-	-	-	-	-	
R7-RB33	3.00"	2.30"	3.00"	2.30"	-	-	-	-	-	-	-	-	-	-	-	-	-	-	-	-	-	
R7-RB34	4.5"	3.45"	4.0"	2.85"	-	-	-	-	-	-	-	-	-	-	-	-	-	-	-	-	-	
R7-RB60	-	-	-	-	3.3"	2.77"	2.95"	-	-	-	-	-	-	-	-	-	-	-	-	-	-	
R7-RB70	4.0"	3.38"	3.5"	2.88"	-	-	-	-	-	-	-	-	-	-	-	-	-	-	-	-	-	
R7-RB120	-	-	-	-	4.0"	2.81"	2.33"	-	-	-	-	-	-	-	-	-	-	-	-	-	-	
R7-RB141	-	-	-	-	-	-	-	-	-	-	-	-	-	-	5.13"	4.11"	4.00"	1.50"	-	-	-	
R7-RB142	-	-	-	-	-	-	-	-	-	-	-	-	-	-	5.13"	4.11"	4.00"	1.50"	-	-	-	
HB-RB150	SEE DIAGRAM ON PAGE 22																					
R7-RB155	4.0"	3.8"	4.0"	3.3"	-	-	-	-	-	-	-	-	-	-	-	-	-	-	-	-	-	
R7-RB160	-	-	-	-	-	-	-	-	-	-	-	-	-	-	5.13"	4.11"	4.00"	1.50"	-	-	-	
R7-RB165	3.5"	2.9"	3.9"	3.37"	-	-	-	-	-	-	-	-	-	-	-	-	-	-	-	-	-	
R7-RB265	5.5"	4.85"	5.0"	4.4"	-	-	-	-	-	-	-	-	-	-	-	-	-	-	-	-	-	
R7-RB320	-	-	-	-	-	-	-	-	-	-	-	-	-	-	4.75"	4.12"	4.80"	1.47"	-	-	-	
R7-RB326	-	-	-	-	-	-	-	-	-	-	-	-	-	-	-	-	-	-	4.42"	5.63"	2.52"	5.02"
R7-RB350	5.3"	4.7"	5.6"	5.0"	-	-	-	-	-	-	-	-	-	-	-	-	-	-	-	-	-	
R7-RB440	-	-	-	-	4.04"	2.81"	2.38"	-	-	-	-	-	-	-	-	-	-	-	-	-	-	
R7-RB445	6.6"	6.0"	5.7"	5.0"	-	-	-	-	-	-	-	-	-	-	-	-	-	-	-	-	-	
R7-RB446	4.61"	3.96"	3.52"	2.87"	-	-	-	-	-	-	-	-	-	-	-	-	-	-	-	-	-	
R7-RB447	6.6"	6.0"	5.7"	5.0"	-	-	-	-	-	-	-	-	-	-	-	-	-	-	-	-	-	
R7-RB462	-	-	-	-	-	-	-	9.43"	8.8"	4.4"	4.4"	5.0"	4.4"	-	-	-	-	-	-	-	-	
R7-RB465	-	-	-	-	-	-	-	9.43"	8.8"	4.4"	4.4"	5.0"	4.4"	-	-	-	-	-	-	-	-	
R7-RB495	6.6"	6.0"	5.6"	5.0"	-	-	-	-	-	-	-	-	-	-	-	-	-	-	-	-	-	
R7-RB500	6.6"	6.0"	5.6"	5.0"	-	-	-	-	-	-	-	-	-	-	-	-	-	-	-	-	-	
R7-RB661	-	-	-	-	3.3"	2.77"	2.36"	-	-	-	-	-	-	-	-	-	-	-	-	-	-	
R7-RB662	-	-	-	-	3.3"	2.77"	2.36"	-	-	-	-	-	-	-	-	-	-	-	-	-	-	
R7-RB665	-	-	-	-	3.3"	4.00"	2.33"	-	-	-	-	-	-	-	-	-	-	-	-	-	-	
R7-RB760	-	-	-	-	-	-	-	9.33"	8.8"	4.4"	4.4"	5.63"	5.06"	-	-	-	-	-	-	-	-	
R7-RB938	-	-	-	-	-	-	-	-	-	-	-	-	-	-	4.75"	4.12"	4.75"	1.50"	-	-	-	
R7-RB991	3.00"	2.00"	3.00"	2.00"	-	-	-	-	-	-	-	-	-	-	-	-	-	-	-	-	-	
HB-RBM121	4.40"	3.75"	4.01"	3.40"	-	-	-	-	-	-	-	-	-	-	-	-	-	-	-	-	-	

Diagrams on next page.

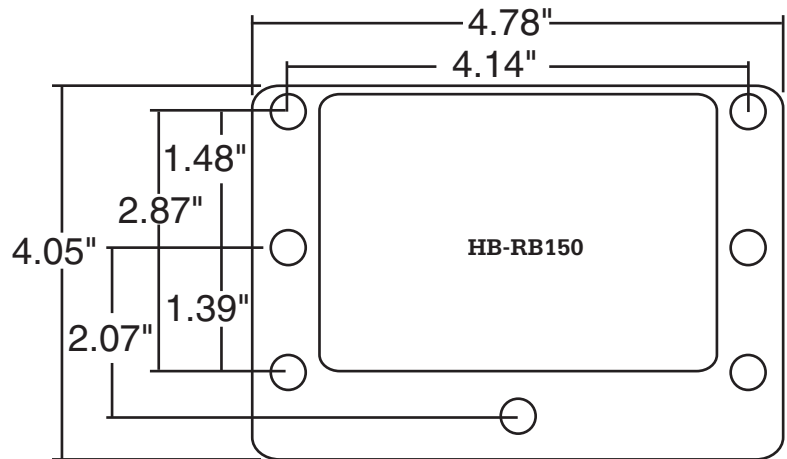
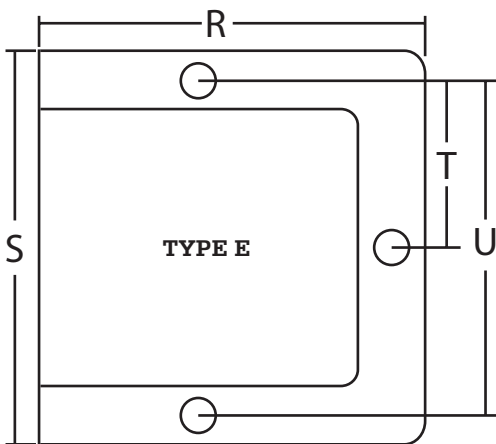
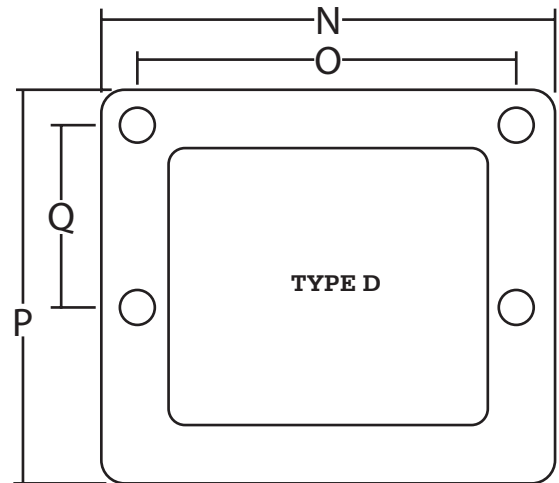
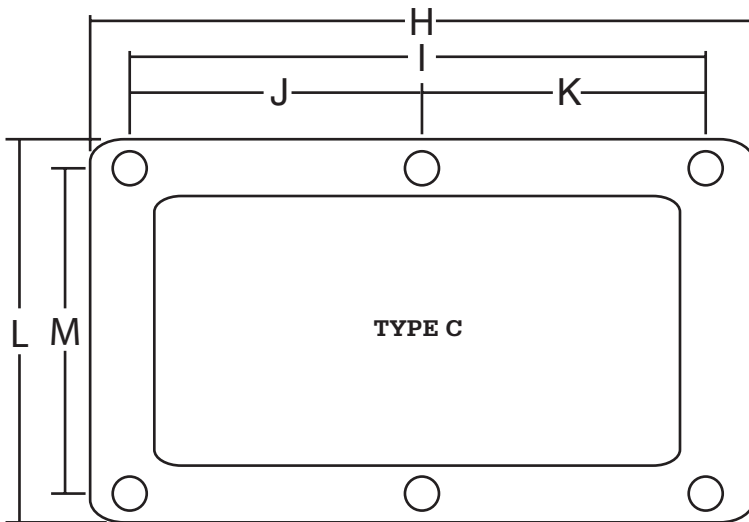
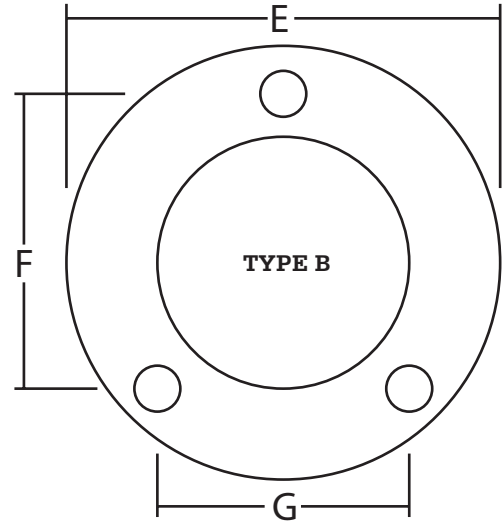
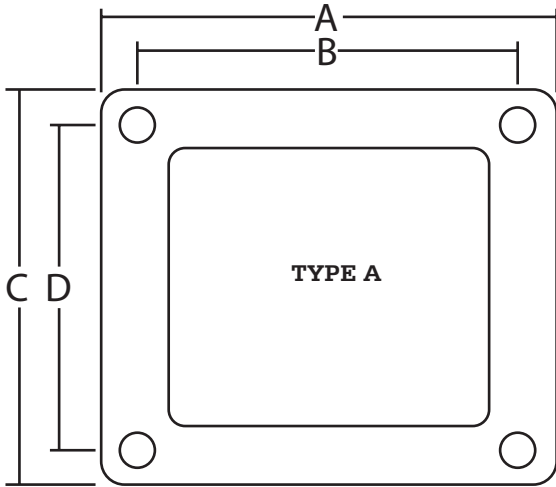

# Index

PART #	PAGE	PART #	PAGE	PART #	PAGE	PART #	PAGE	PART #	PAGE	PART #	PAGE
29-159-1	17	61-65010	20	T9-DB68	15	HM-R1139	2	HB-RB130	4	T8-RF205	11
29-159-3	17	61-65015	20	T9-DB144	15	HB-RB006	6	R7-RB141	13	T8-RF210	11
29-159-5	17	61-65016	20	T9-DB164	15	R7-RB1	13	R7-RB142	13	T8-RF215	11
13-536-10	19	61-65017	20	T9-DB204C	15	R7-RB2	12	HB-RB150	9,22	T8-RF220	11
15-26804	24	61-65019	20	T9-DB205C	15	R7-RB3	6,12	R7-RB151	13	T8-RF225	11
15-26832	24	61-70550	20	T9-DB206C	15	R7-RB4	12	R7-RB155	2,13	T8-RF230	11
61-30002	20	61-70570	20	T9-DB208C	15	HB-RB12	5	R7-RB160	13	T8-RF235	6,7,11
61-30003	20	61-70606	20	T9-DB210C	15	HB-RB21K	3	HB-RB166	5,6,7	T8-RF236	11
61-30007	20	61-70721	20	T9-DB212C	15	HB-RB27	8	HB-RB167	7	T8-RF237	11
61-30009	20	61-70722	20	T9-DF100	16	HB-RB32	7	HB-RB168	3	T8-RF240	11
61-30021	20	61-70766	20	T9-DS45110	16	R7-RB33	3,7,12	HB-RB168-1	17	T8-RF245	11
61-30022	20	61-83491	19	T9-EQ2	16	R7-RB34	2,3	HB-RB168-2	17	T8-RF247	11
61-30023	20	61-83501	19	06-FGV1	18	HB-RB35	4	HB-RB168B	3	T8-RF248	11
61-30031	20	61-83521	19	06-FGV1P	18	HB-RB36	4	HB-RB179	6	T8-RF249	11
61-30033	20	61-83541	19	06-FGV2P	18	HB-RB37	4	R7-RB180	13	T8-RF250	11
61-30035	20	61-83561	19	06-FGV12	18	HB-RB38	8	HB-RB200T	2	T8-RF255	11
61-30061	20	61-83581	19	06-FGV12P	18	HB-RB38-1	17	R7-RB245	13	HM-RGM450	8
61-30065	20	61-84331	20	06-FGV34	18	HB-RB38B	8	HB-RB250	4	HM-RGM451	8
61-30071	20	61-84332	20	06-FGV34P	18	HB-RB39	8	HB-RB261	2	HM-RGM452	8
61-30073	20	61-84333	20	06-FGV38	18	HB-RB39B	8	R7-RB265	13	HM-RGM453	8
83-30200	18	61-84334	20	06-FGV38P	18	HB-RB41	10	R7-RB266	14	HM-RGM454	8
83-30201	18	61-84351	20	06-FGV112	18	HB-RB42	10	HB-RB267	7	HM-RGM651	8
83-30202	18	61-84352	20	06-FGV112P	18	HB-RB45	10	R7-RB312	13	78-SC1600L	24
83-30203	18	61-84371	20	06-FGV114P	18	HB-RB46	10	R7-RB320	14	78-SC1600VL	24
83-30205	18	61-84372	20	06-FHGV12	18	HB-RB50	6	R7-RB326	14	78-SC1601	24
83-30209	18	61-84380	20	06-FHGV34	18	HB-RB53	7	R7-RB350	14	19-SF2-115	17
83-30213	18	61-84385	20	06-FP1212	18	HB-RB53B	7	R7-RB440	2,12	06-SWV12	18
83-30280	18	12-451070-24	19	06-FP1238	18	R7-RB54	13	R7-RB445	2,14	06-SWV34	18
83-30281	18	12-457070-24	19	06-FP3458	18	R7-RB55	12	R7-RB446	2,13	T9-TW208	16
83-30283	18	12-462570-24	19	19-FS2-110	17	HB-RB58	5	R7-RB447	2,14	T9-TW8-2	16
83-30289	18	12-470570-24	19	19-FS2-120	17	HB-RB58-1	17	R7-RB462	14	10-ZS75	10
83-30293	18	12-475570-24	19	19-FS2-130	17	HB-RB59	5	R7-RB465	14		
61-30600	19	92-A8301	17	19-FS2-160	17	R7-RB60	12	R7-RB495	14		
61-30601	19	92-A8301-1	17	19-FS2-200	17	HB-RB61	5,10	R7-RB500	14		
61-30606	19	92-A8303	17	06-GWH12	18	HB-RB63	5	HB-RB513	6		
61-30700	19	92-A8303-1	17	06-GWH34	18	HB-RB64	4,7,10	HB-RB555	8		
61-30707	19	92-A8305	17	T9-HC500-B	16	HB-RB65	5	HB-RB571	6		
61-30708	19	92-A8306	17	T9-HC500-W	16	HB-RB66	10	HB-RB611	10		
61-30800	19	78-ACCWP03	24	19-LS2-120	17	HB-RB67	7	HB-RB621	5		
61-30801	19	78-ACCWP04	24	19-LS2-135	17	HB-RB67-1	17	R7-RB661	12		
61-30808	19	06-BGV12	18	19-LS2-140	17	HB-RB67-2	17	R7-RB662	12		
61-30809	19	06-BGV34	18	19-LS2-145	17	HB-RB67-3	17	R7-RB663	12		
61-30900	19	15-C15650	24	19-LS2-150	17	HB-RB67-5	17	R7-RB665	12		
61-31000	19	15-C23319	24	19-LS2-160	17	HB-RB68	3	HB-RB735	4		
61-31001	19	15-C26822	24	19-LS2-165	17	HB-RB68-1	17	HB-RB755	8		
61-31006	19	T8-CFC-T24	11	19-LS2-180	17	HB-RB69	10	R7-RB760	14		
61-31008	19	T8-CFC-T24P	11	19-LS2-190	17	R7-RB70	12	HB-RB822	10		
61-31010	19	T8-CFC-T48P	11	19-LS2-200	17	HB-RB79	3,10	HB-RB861	7		
61-31011	19	T8-CFC-T72	11	19-LS2-200F	17	HB-RB81	7	R7-RB885	12		
61-31107	19	T8-CFC-T72P	11	19-LS2-240	17	HB-RB82	3,4,10	R7-RB938	14		
61-31108	19	T8-CFG-120M	11	19-LS2-250	17	HB-RB83	6	HB-RB939	9		
61-31200	19	T8-CFG-120P	11	19-LS2-275	17	HB-RB84	10	HB-RB944	6,9		
61-31205	19	T8-CFG-150M	11	19-LS2-290	17	HB-RB85	7	HB-RB949	9		
61-31208	19	T8-CFG-254M	11	19-LS2-320	17	HB-RB86	10	HB-RB950	9		
61-31213	19	T8-CFG-60M	11	T9-MD6-NC	15	HB-RB87	7	R7-RB965	14		
61-31401	19	T8-CFG-80M	11	T9-MD6-NO	15	HB-RB88	7	HB-RB981	2		
61-33110	19	T8-CFG-80P	11	T9-MD8-NC	15	HB-RB89	7	R7-RB991	12		
61-33140	19	T8-CFG-92M	11	T9-MD8-NO	15	R7-RB90	12	R7-RB1000	14		
61-33150	19	15-CG000113	19	T9-MD10-NC	15	HB-RB91	4	R7-RB1600	14		
61-33170	19	15-CG000138	19	T9-MD10-NO	15	HB-RB94	5	HB-RB6001	4		
61-33190	19	T9-DB6-2	15	T9-MD12-NC	15	HB-RB95	5	HB-RBM120	9		
61-33200	19	T9-DB6-2CR	15	T9-MD12-NO	15	HB-RB96	9	HB-RBM121	9		
61-33210	19	T9-DB8-2	15	HM-R250	2	HB-RB100	4	T1-RF100-2	5		
61-65000	20	T9-DB10-2	15	HM-R325	4	HB-RB108	6	T8-RF200	11		
61-65001	20	T9-DB124	15	HM-R489	2	R7-RB120	13	T8-RF201	11		
61-65009	20	T9-DB12R	15	HM-R1138	2	HB-RB125	3	T8-RF202	11		



# The Tradition of Quality Continues!

From the trusted suppliers of **Spray Nine®** comes the complete cleaning solution to all your seasonal projects. BBQ Grill, Wood Stove and Gas Fireplace, we've got a premium cleaner for all cleaning needs.

**Spray Nine®** Seasonal Cleaners are available thru Rotom, your single source for Fireview and Gas Fireplace cleaners.

### BBQ Grill Cleaner | Complete Barbecue Cleaner

15-C15650 • 650 ml spray bottle • 6/ctn

### Spray Nine Premium | Multi-Purpose Cleaner/Degreaser/Disinfectant

15-C26822 • 650 ml spray bottle • 6/ctn

15-26832 • 946 ml spray bottle • 12/ctn

15-26804 • 4L Jug • 4/ctn

### Glass & Stainless Steel Cleaner | All-Purpose Glass Cleaner

15-C23319 • 600g aerosol can style • 12/ctn

## Fireplace Thermostat



**LOGO HERE!**  
Ask About Our  
Private Branding  
Program For You  
Or Your Customer!

Who Will Your Customer Call The Next Time  
Their Fireplace Or Stove Requires Service?

### 78-SC1600L Fireplace Thermostat - Features

- Elegant design.
- Easy to operate.
- Zoning system compatible.
- Adjustable differential.
- Large LCD temperature display.
- Precise temperature sensing.
- Easy access terminal block.
- Freeze protection.
- Compatible with standard 24V AC heating/ cooling systems.
- Integral five minute anti-short cycle protection.
- Mercury free environment safe.
- Manual changeover.
- Battery (included).
- Ideal for electric, gas, oil and hydronic systems.

**Millivolt Compatible!**  
**Battery Operated!**  
**Freeze Protected!**

### Digital Fireplace Thermostat

Part #	Description
<b>78-SC1600L</b> <b>78-SC1600VL</b>	<ul style="list-style-type: none"> <li>• Non-programmable.</li> <li>• Single stage heat only.</li> <li>• No fan.</li> </ul>
<b>78-ACCWP03</b> <b>78-ACCWP04</b>	<ul style="list-style-type: none"> <li>• Large insulated thermostat wall plate</li> <li>• Small insulated thermostat wall plate</li> </ul>

\*Hard wire model available 78-SC1601

**SC1600 are now C°/F° selectable**



SC1600VL

ACCWP03

ACCWP04